

Part Numbers	Specifications	Applications	Features	Options
<b>6403297</b> PUSHER / PULLER	<b>DIAMETER 16" (385 mm)</b> <b>LOW PROFILE</b> <b>12V 225W</b>	HVAC Systems	Waterproof, IP68 (LL) Long Life Reversible Airflow High Efficiency	Mounting brackets EMC (Certified) Thermal Protector (ELL) Extreme Long Life

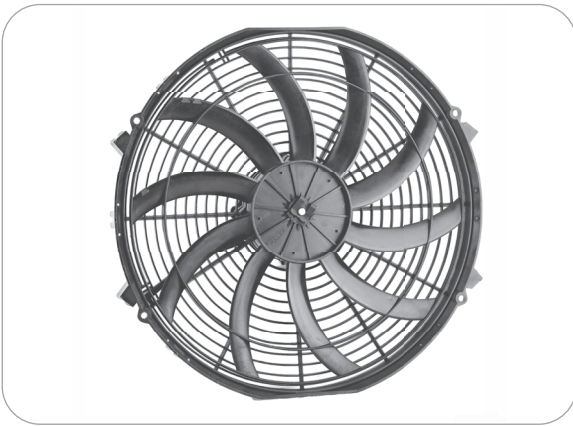

Test Voltage	V	13,0
Nominal Current	A	17,5
Nominal Speed	rpm	2.750
Max. St. Pressure	mmH <sub>2</sub> O	20,5
Max. Airflow	m <sup>3</sup> /h	3.300
Weight	kg	2,4

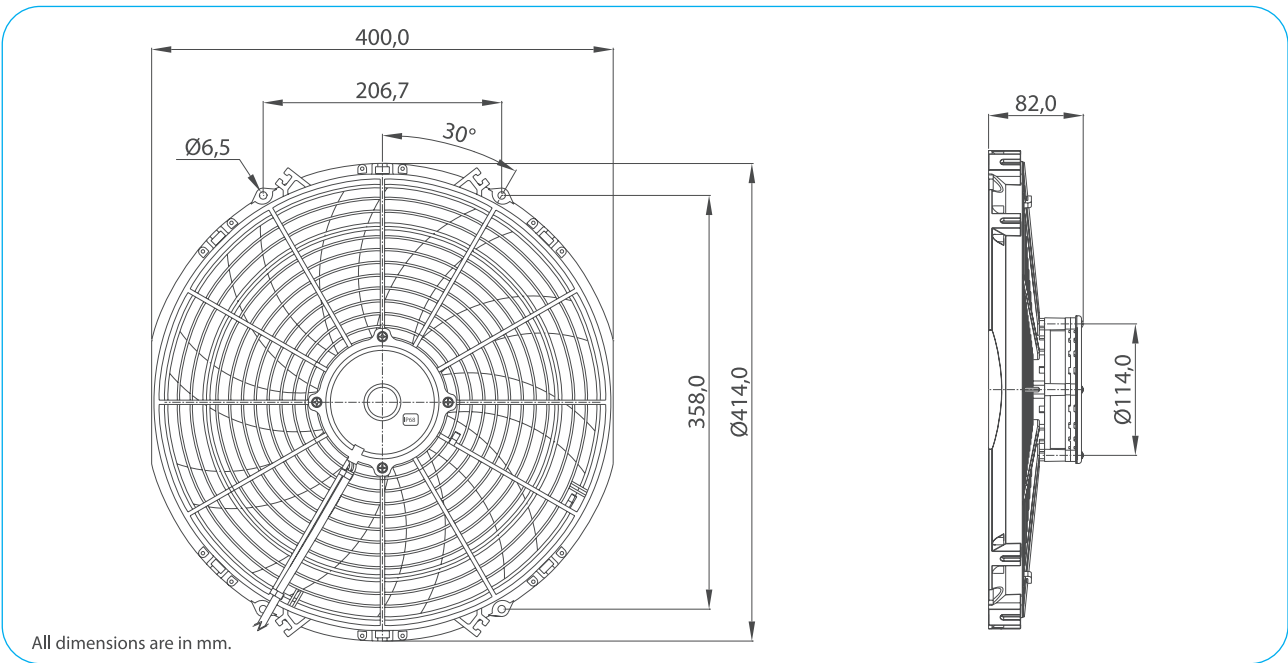

TEST VOLTAGE = 13,0 VDC	Static Pressure	Air Flow Rate	Current
	mm H <sub>2</sub> O	m <sup>3</sup> /h	A
	0,0	3303,5	16,8
	2,5	3120,2	17,3
	5,0	2876,4	17,7
	7,5	2530,2	18,0
	10,0	2106,9	17,9
	12,5	1629,4	17,1
	15,0	1128,7	16,3
	17,5	630,4	16,1
20,6	0,0	16,4	

Static Pressure: 1 mm H<sub>2</sub>O = 0,04in H<sub>2</sub>O = 9,8 Pa  
Air Flow Rate: 1 m<sup>3</sup>/h = 0,59 cfm

