

Part Numbers	Specifications	Applications	Features	Options
6401591 THREE SPEED	WIDTH 350 mm 1000 m³/h 24V	HVAC Systems	High Pressure Silent Operation High Efficiency	PWM Speed Control EMC (Certified) Thermal Protector (LL) Long Life Version

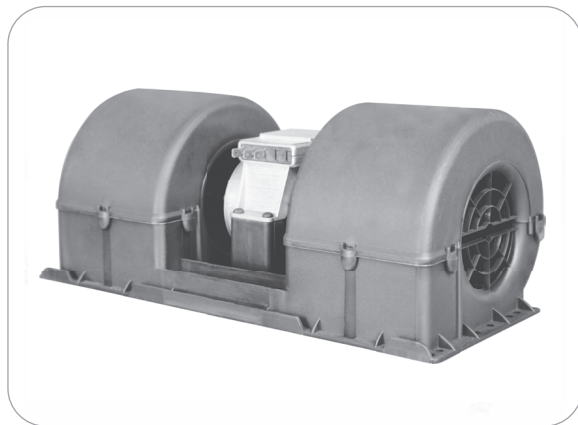

Test Voltage	V	26,0
Nominal Current	A	11,5
Nominal Speed	rpm	3.800
Max. St. Pressure	mmH ₂ O	77,5
Max. Airflow	m ³ /h	1.030
Weight	kg	2,0
Airflow Rates	%	100-73-60

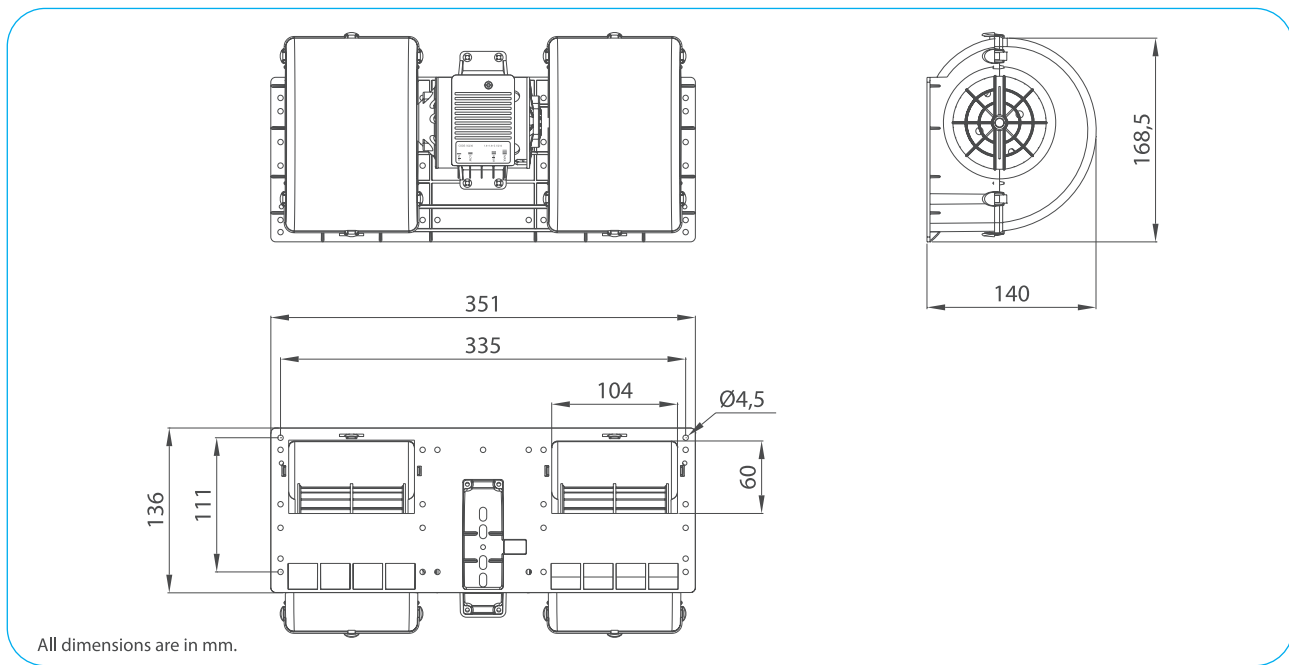

TEST VOLTAGE = 26,0 VDC	Static Pressure	Air Flow Rate	Current
	mm H ₂ O	m ³ /h	A
	0,0	1030,0	11,4
	5,0	1008,1	11,1
	10,0	982,7	10,8
	20,0	913,1	10,2
	30,0	811,1	9,4
	40,0	691,3	8,6
	50,0	546,0	7,4
	60,0	315,1	5,4
70,0	111,9	4,1	
77,5	0,0	3,9	

Static Pressure: 1 mm H₂O = 0,04in H₂O = 9,8 Pa
Air Flow Rate: 1 m³/h = 0,59 cfm

