

Part Numbers	Specifications	Applications	Features	Options
6401560 ONE SPEED	WIDTH 310 mm 650 m³/h 12V	HVAC Systems	High Pressure Silent Operation High Efficiency	Speed Control EMC (Certified) Thermal Protector (LL) Long Life Version

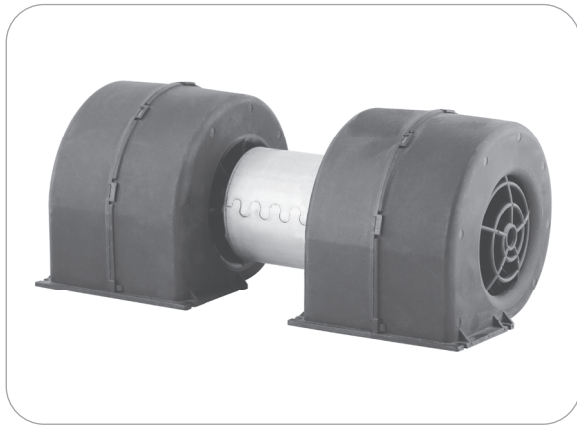

Test Voltage	V	13,0
Nominal Current	A	9,0
Nominal Speed	rpm	3.250
Max. St. Pressure	mmH ₂ O	33,0
Max. Airflow	m ³ /h	645
Weight	kg	1,8

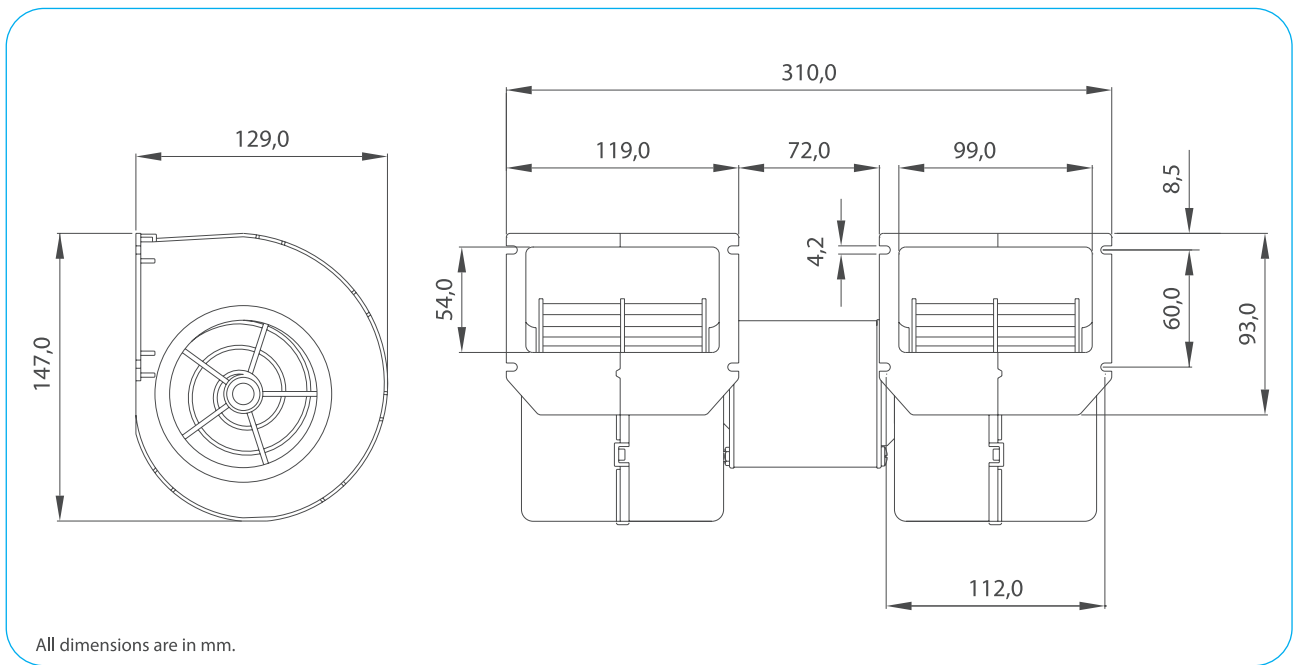

TEST VOLTAGE = 13,0 VDC

Static Pressure	Air Flow Rate	Current
mm H ₂ O	m ³ /h	A
0,0	644,2	8,7
2,5	623,8	8,4
5,0	601,6	8,2
7,5	577,2	7,9
10,0	549,7	7,6
15,0	494,8	7,1
20,0	426,0	6,4
25,0	308,8	5,0
30,0	124,0	3,5
32,8	0,0	2,7

Static Pressure: 1 mm H₂O = 0,04in H₂O = 9,8 Pa
Air Flow Rate: 1 m³/h = 0,59 cfm

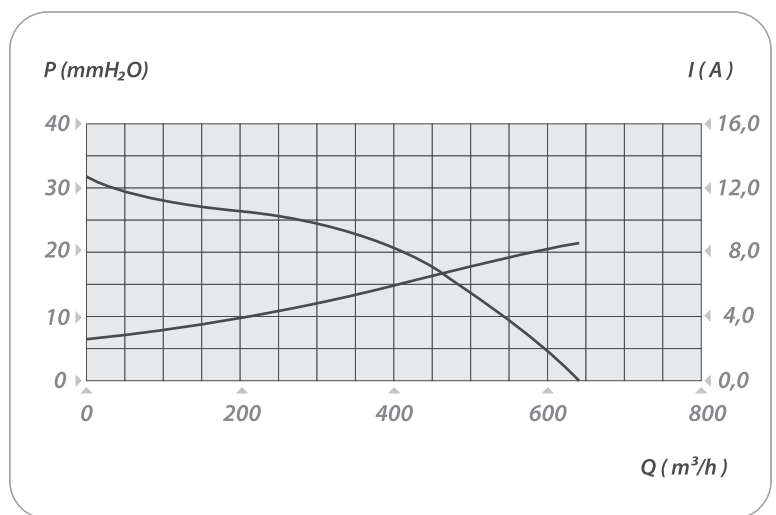

2 X SINGLE BLOWERS