

2 X SINGLE BLOWERS

Part Numbers	Specifications	Applications	Features	Options
6401540 THREE SPEED	WIDTH 310 mm 650 m³/h 24V	HVAC Systems	High Pressure Silent Operation High Efficiency	PWM Speed Control EMC (Certified) Thermal Protector (LL) Long Life Version

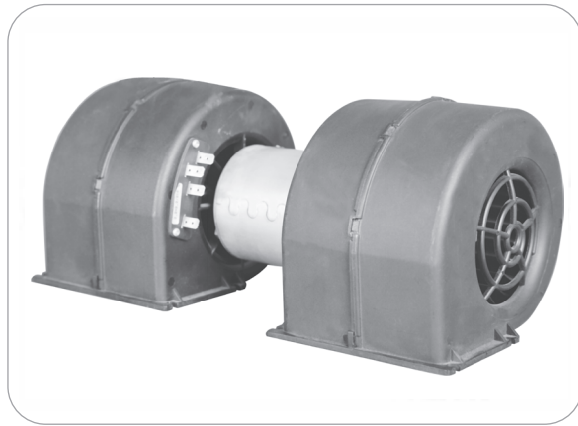

Test Voltage	V	26,0
Nominal Current	A	4,2
Nominal Speed	rpm	3.250
Max. St. Pressure	mmH ₂ O	34,0
Max. Airflow	m ³ /h	650
Weight	kg	1,9
Airflow Rates	%	100-77-66

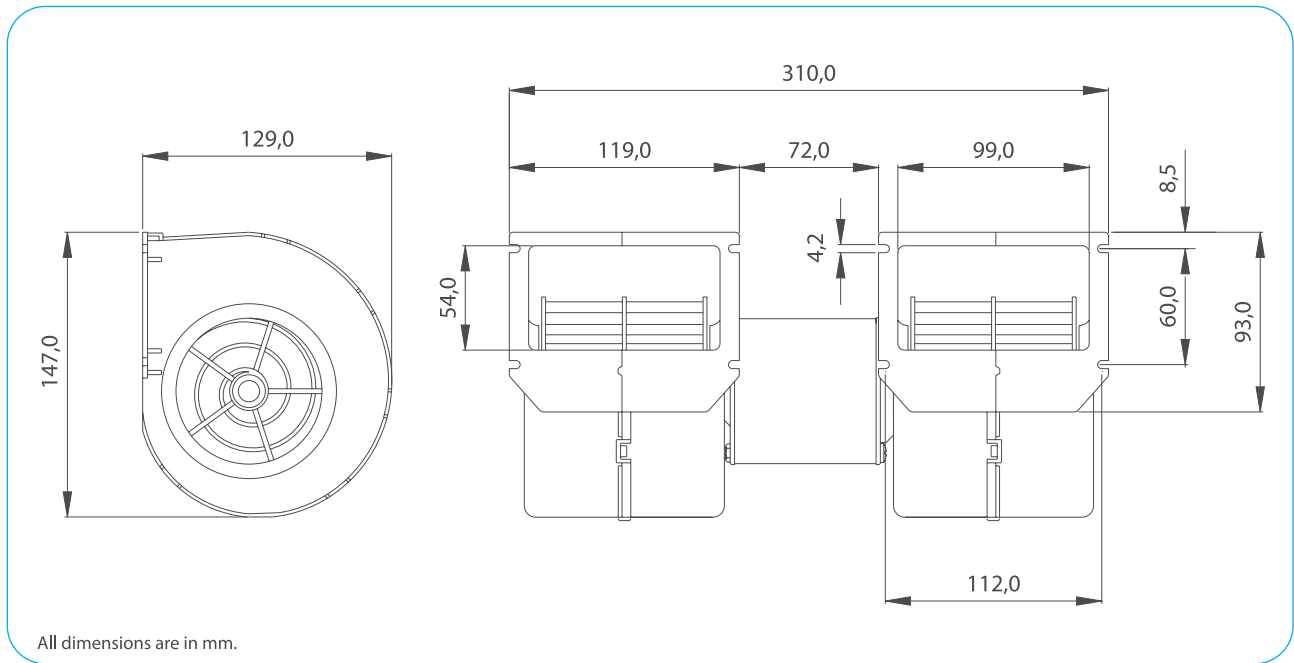

TEST VOLTAGE = 26,0 VDC	Static Pressure	Air Flow Rate	Current
	mm H ₂ O	m ³ /h	A
	0,0	651,3	4,2
	2,5	629,6	4,1
	5,0	606,6	4,0
	7,5	582,9	3,9
	10,0	557,1	3,7
	15,0	502,3	3,4
	20,0	431,1	3,1
	25,0	314,1	2,4
30,0	144,7	1,8	
33,6	0,0	1,4	

Static Pressure: 1 mm H₂O = 0,04 in H₂O = 9,8 Pa
Air Flow Rate: 1 m³/h = 0,59 cfm

