

Part Numbers	Specifications	Applications	Features	Options
6401570 THREE SPEED	WIDTH 310 mm 850 m³/h 12V	HVAC Systems	High Pressure Silent Operation High Efficiency	PWM Speed Control EMC (Certified) Thermal Protector (LL) Long Life Version

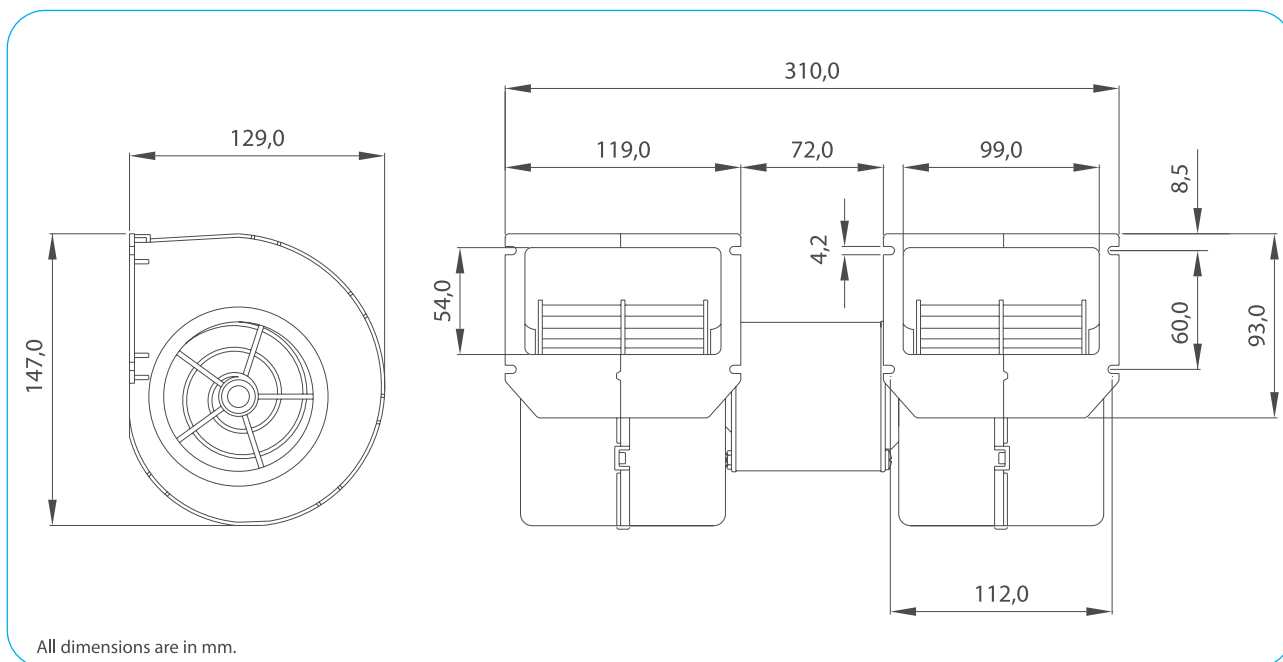

Test Voltage	V	13,0
Nominal Current	A	21,0
Nominal Speed	rpm	4.200
Max. St. Pressure	mmH ₂ O	75,5
Max. Airflow	m ³ /h	815
Weight	kg	1,9
Airflow Rates	%	100-72-60



TEST VOLTAGE = 13,0 VDC	Static Pressure	Air Flow Rate	Current
	mm H ₂ O	m ³ /h	A
	0,0	815,0	21,1
	5,0	782,3	20,5
	10,0	749,3	19,8
	20,0	687,9	18,6
	30,0	630,4	17,3
	40,0	565,6	16,2
	50,0	449,4	14,0
	60,0	273,4	10,5
70,0	93,8	7,4	
75,5	0,0	6,0	

Static Pressure: 1 mm H₂O = 0,04in H₂O = 9,8 Pa
Air Flow Rate: 1 m³/h = 0,59 cfm

