

Part Numbers	Specifications	Applications	Features	Options
6401815 THREE SPEED	HEIGHT 114 mm 260 m³/h 24V	HVAC Systems	Waterproof, IP68 (LL) Long Life High Efficiency	Mounting brackets EMC (Certified) Thermal Protector (ELL) Extreme Long Life

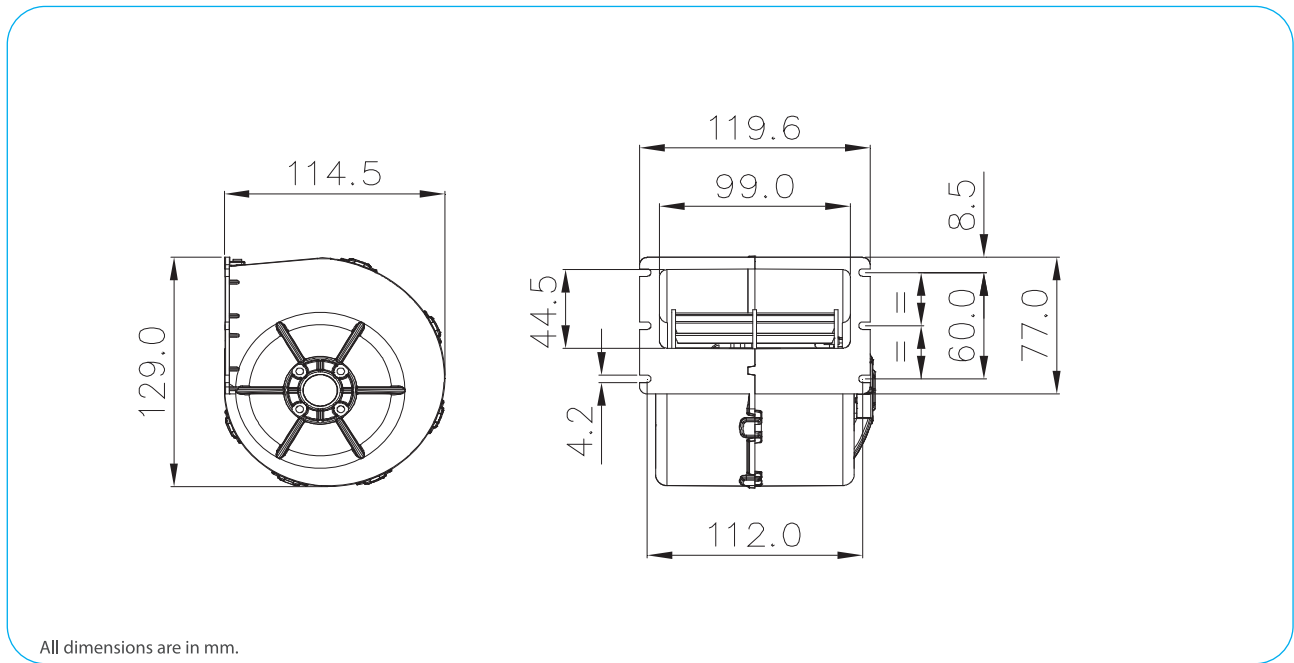

Test Voltage	V	26,0
Nominal Current	A	2,2
Nominal Speed	rpm	3.600
Max. St. Pressure	mmH ₂ O	390
Max. Airflow	m ³ /h	260
Weight	kg	0,8
Airflow Rates	%	100-85-75



TEST VOLTAGE = 26,0 VDC	Static Pressure	Air Flow Rate	Current
	mm H ₂ O	m ³ /h	A
	0,0	260,0	2,3
2,5	253,0	2,2	
5,0	246,2	2,2	
10,0	227,5	2,1	
15,0	198,1	2,0	
20,0	172,2	1,9	
25,0	141,0	1,7	
30,0	102,4	1,5	
35,0	51,4	1,3	
39,7	0,0	1,1	

Static Pressure: 1 mm H₂O = 0,04in H₂O = 9,8 Pa
Air Flow Rate: 1 m³/h = 0,59 cfm

