

Part Numbers	Specifications	Applications	Features	Options
6401511 ONE SPEED	HEIGHT 142 mm 500 m³/h 24V	HVAC Systems	High Pressure Compact Design High Efficiency	PWM Speed Control EMC (Certified) Thermal Protector

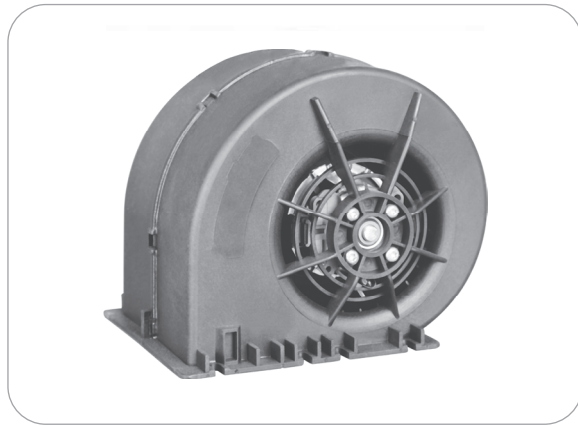

Test Voltage	V	26,0
Nominal Current	A	7,5
Nominal Speed	rpm	3.650
Max. St. Pressure	mmH ₂ O	76,0
Max. Airflow	m ³ /h	505
Weight	kg	1,2

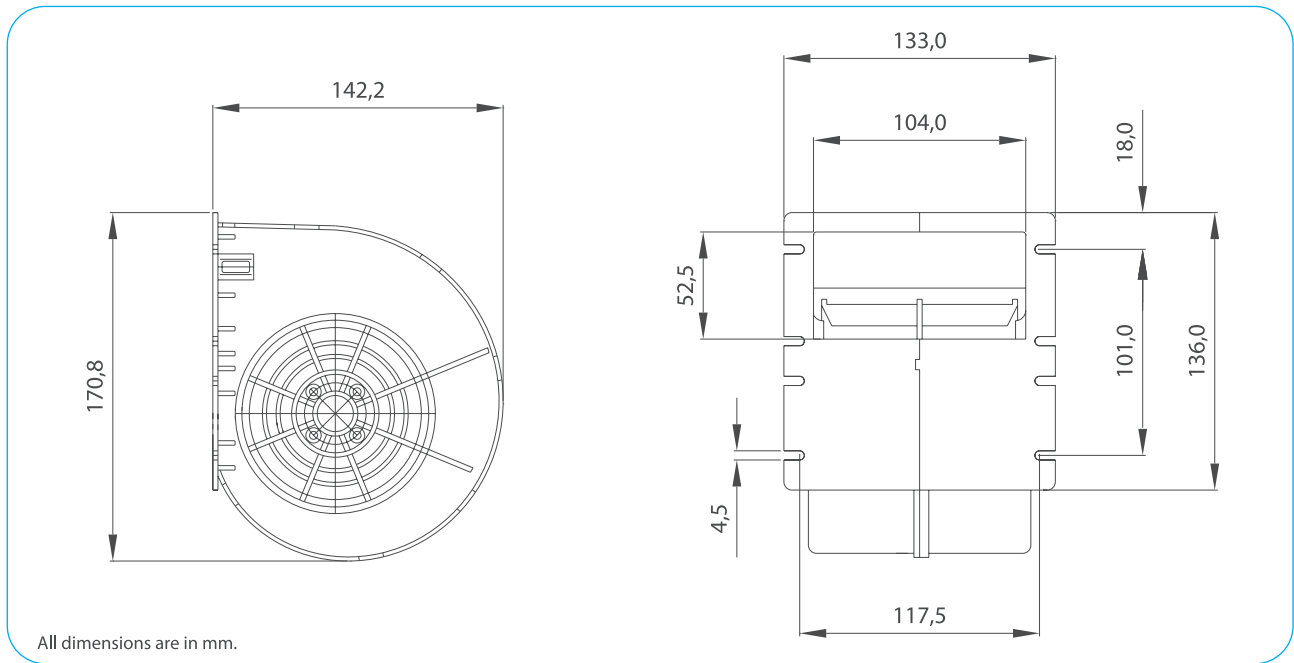

TEST VOLTAGE = 26,0 VDC	Static Pressure	Air Flow Rate	Current
	mm H ₂ O	m ³ /h	A
	0,0	505,2	7,4
	5,0	488,5	7,2
	10,0	472,2	7,0
	20,0	440,7	6,6
	30,0	410,9	6,3
	40,0	366,8	5,7
	50,0	308,3	5,1
	60,0	239,0	4,3
70,0	107,4	3,2	
76,3	0,0	2,4	

Static Pressure: 1 mm H₂O = 0,04in H₂O = 9,8 Pa
Air Flow Rate: 1 m³/h = 0,59 cfm

