

Part Numbers	Specifications	Applications	Features	Options
6401550 ONE SPEED / CCW	HEIGHT 222 mm 550 m³/h 12V	HVAC Systems	High Pressure Compact Design High Efficiency Waterproof, IP68	PWM Speed Control EMC (Certified) Thermal Protector

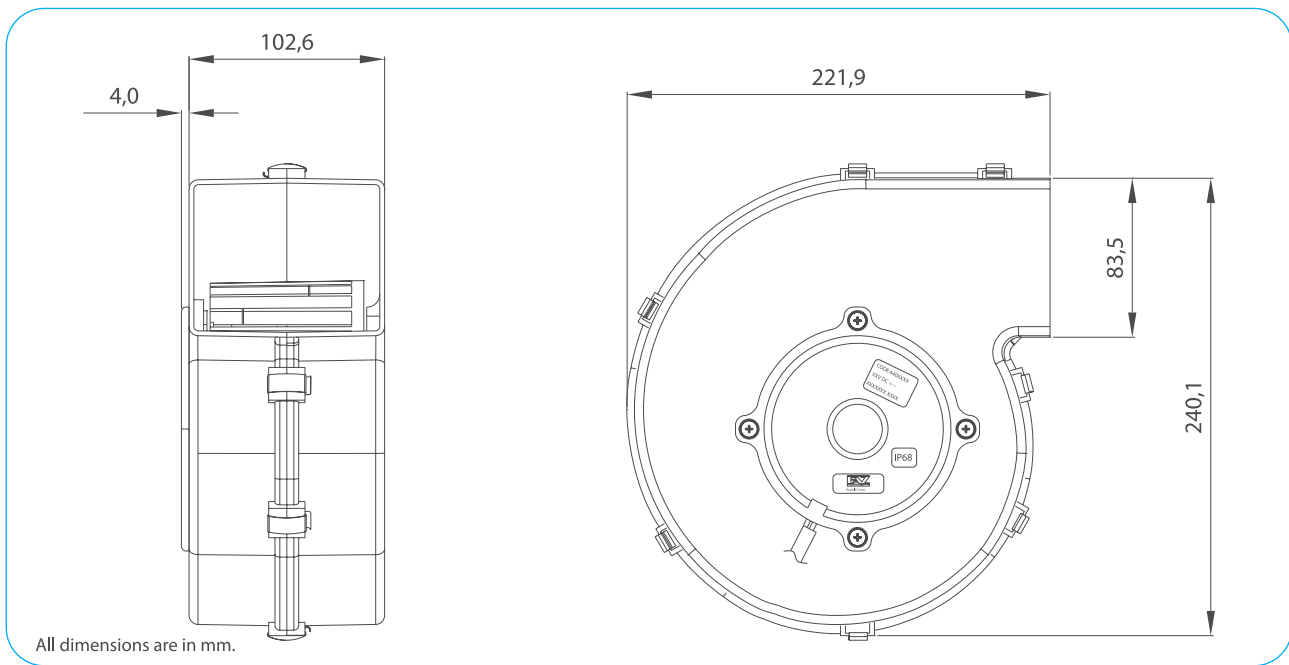

Test Voltage	V	13,0
Nominal Current	A	14,0
Nominal Speed	rpm	2.800
Max. St. Pressure	mmH ₂ O	62,0
Max. Airflow	m ³ /h	550
Weight	kg	2,0



TEST VOLTAGE = 13,0 VDC

Static Pressure	Air Flow Rate	Current
mm H ₂ O	m ³ /h	A
0,0	548,8	13,5
5,0	524,4	13,1
10,0	500,2	12,7
15,0	475,8	12,3
20,0	451,3	11,9
25,0	424,1	11,4
30,0	393,4	10,8
40,0	300,9	8,9
50,0	163,5	6,5
61,8	0,0	5,6

Static Pressure: 1 mm H₂O = 0,04in H₂O = 9,8 Pa
Air Flow Rate: 1 m³/h = 0,59 cfm

