

Part Numbers	Specifications	Applications	Features	Options
<b>6401569</b> ONE SPEED	<b>HEIGHT 203 mm</b> <b>550 m<sup>3</sup>/h</b> <b>12V</b>	HVAC Systems	High Pressure Compact Design High Efficiency	PWM Speed Control EMC (Certified) Thermal Protector

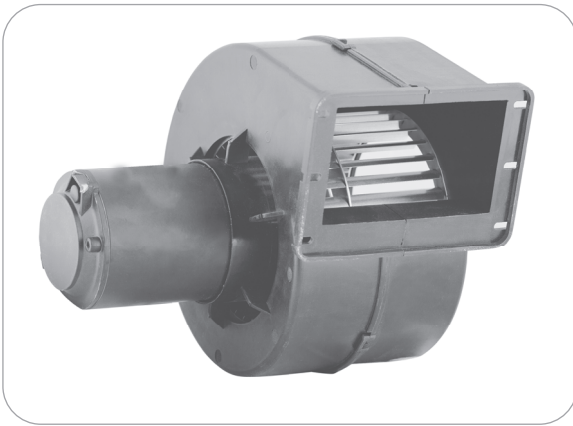

Test Voltage	V	13,0
Nominal Current	A	9,5
Nominal Speed	rpm	2.300
Max. St. Pressure	mmH <sub>2</sub> O	41,0
Max. Airflow	m <sup>3</sup> /h	560
Weight	kg	2,1

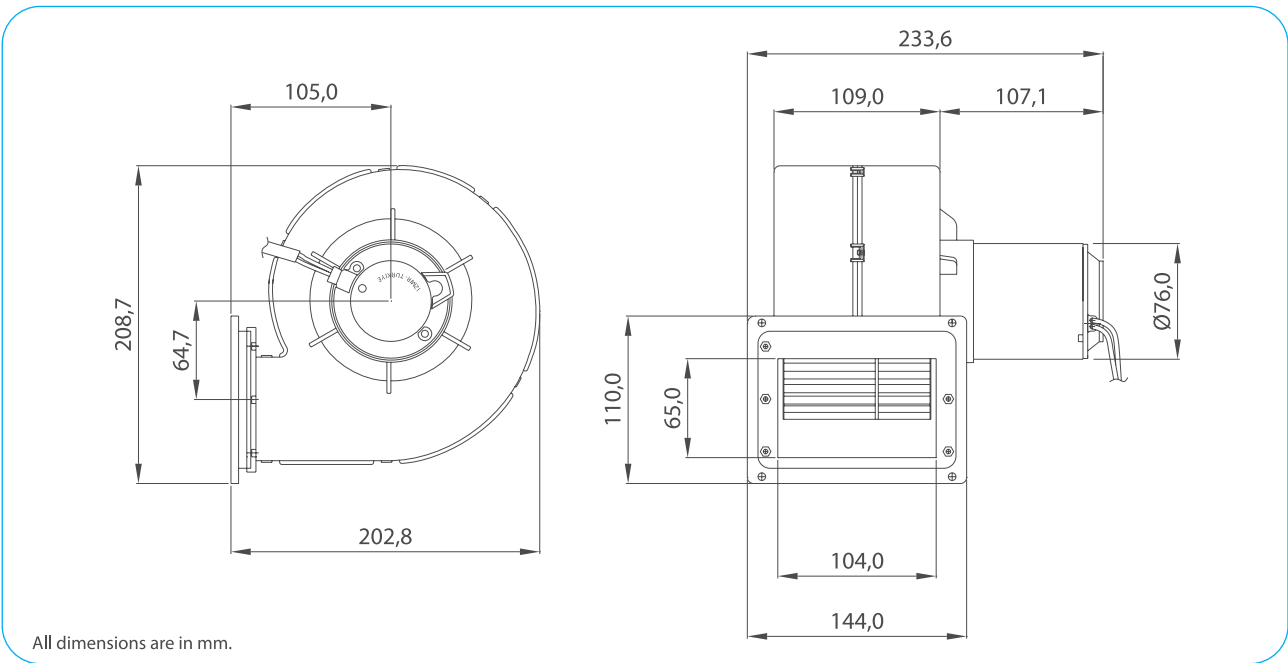

TEST VOLTAGE = 13,0 VDC	Static Pressure	Air Flow Rate	Current
	mm H <sub>2</sub> O	m <sup>3</sup> /h	A
	0,0	562,2	9,7
	2,5	548,7	9,5
	5,0	535,0	9,2
	10,0	505,2	8,7
	15,0	471,6	8,1
	20,0	434,7	7,5
	25,0	398,6	6,8
	30,0	341,9	5,9
35,0	221,0	4,7	
41,2	0,0	2,9	

Static Pressure: 1 mm H<sub>2</sub>O = 0,04in H<sub>2</sub>O = 9,8 Pa  
Air Flow Rate: 1 m<sup>3</sup>/h = 0,59 cfm

