

Part Numbers	Specifications	Applications	Features	Options
6401521 ONE SPEED	HEIGHT 203 mm 550 m³/h 24V	HVAC Systems	High Pressure Compact Design High Efficiency	PWM Speed Control EMC (Certified) Thermal Protector

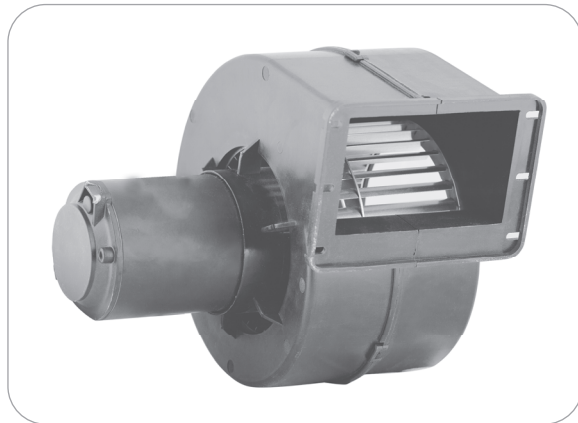

Test Voltage	V	26,0
Nominal Current	A	4,5
Nominal Speed	rpm	2.300
Max. St. Pressure	mmH ₂ O	39,0
Max. Airflow	m ³ /h	560
Weight	kg	2,1

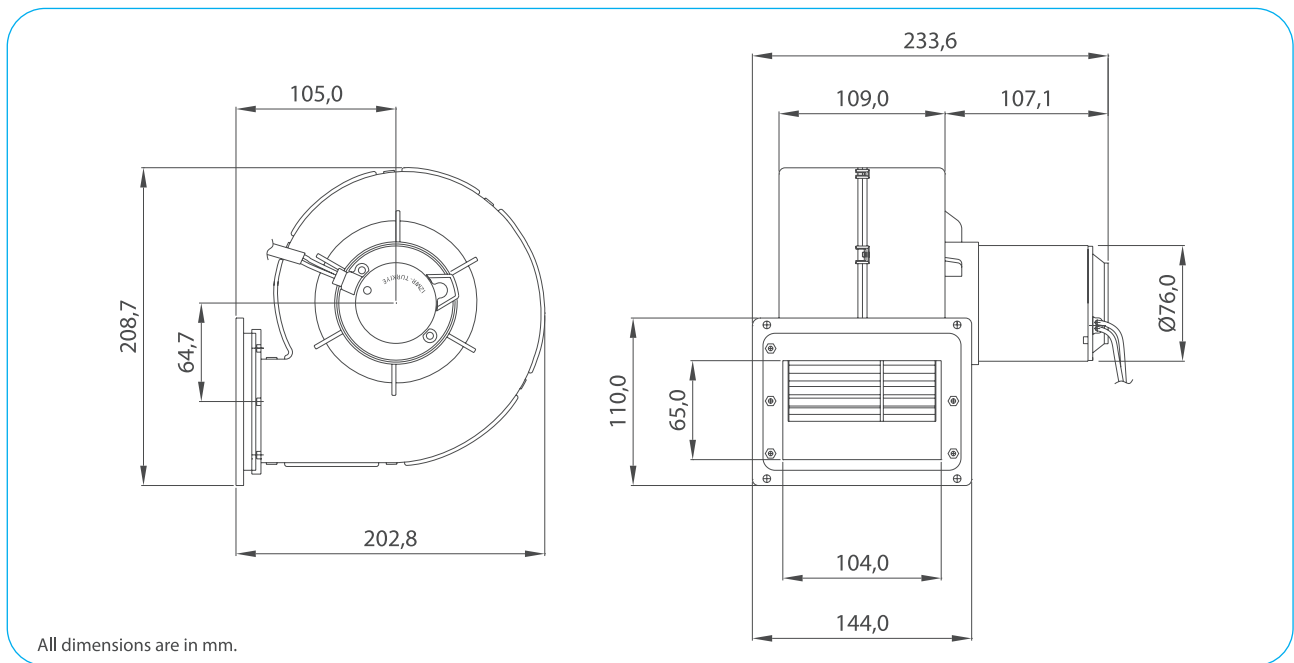

TEST VOLTAGE = 26,0 VDC	Static Pressure	Air Flow Rate	Current
	mm H ₂ O	m ³ /h	A
	0,0	560,4	4,4
	2,5	543,3	4,3
	5,0	526,8	4,2
	10,0	495,3	3,8
	15,0	458,6	3,5
	20,0	403,8	3,1
	25,0	377,5	2,8
	30,0	252,1	2,1
35,0	18,3	0,9	
39,0	0,0	1,2	

Static Pressure: 1 mm H₂O = 0,04in H₂O = 9,8 Pa
Air Flow Rate: 1 m³/h = 0,59 cfm

