

Part Numbers	Specifications	Applications	Features	Options
<b>6401110</b> ONE SPEED	<b>HEIGHT 126 mm</b> <b>145 m<sup>3</sup>/h</b> <b>12V</b>	HVAC Systems	High Pressure Compact Design High Efficiency	PWM Speed Control EMC (Certified) Thermal Protector

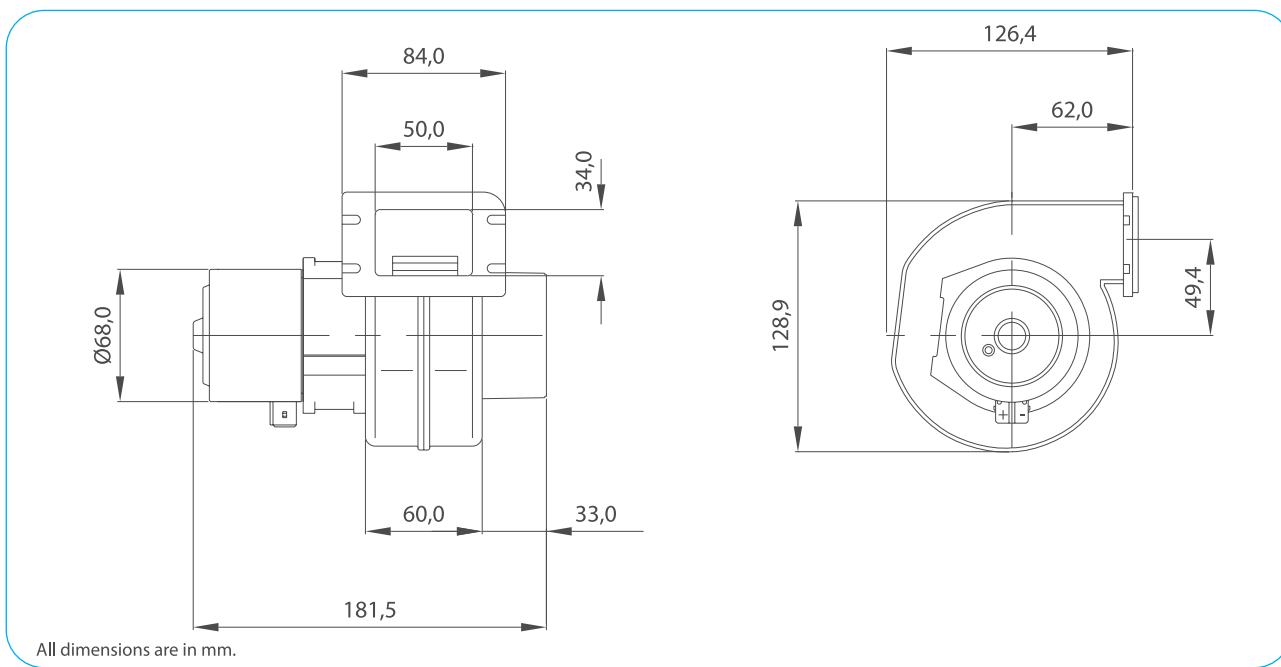

Test Voltage	V	13,0
Nominal Current	A	3,3
Nominal Speed	rpm	4.550
Max. St. Pressure	mmH <sub>2</sub> O	40,0
Max. Airflow	m <sup>3</sup> /h	145
Weight	kg	0,95



TEST VOLTAGE = 13,0 VDC	Static Pressure	Air Flow Rate	Current
	mm H <sub>2</sub> O	m <sup>3</sup> /h	A
	0,0	143,0	3,2
	2,5	139,4	3,1
	5,0	135,7	3,0
	10,0	127,9	2,7
	15,0	119,6	2,5
	20,0	110,8	2,3
	25,0	103,4	2,3
	30,0	100,4	2,2
35,0	75,3	1,8	
39,9	0,0	0,8	

Static Pressure: 1 mm H<sub>2</sub>O = 0,04in H<sub>2</sub>O = 9,8 Pa  
Air Flow Rate: 1 m<sup>3</sup>/h = 0,59 cfm

