

Part Numbers	Specifications	Applications	Features	Options
6401295 PULLER / STR. BLADE	DIAMETER 9" (225 mm)	HVAC Systems	Waterproof, IP68 (LL) Long Life High Efficiency	Mounting brackets EMC (Certified) Thermal Protector (ELL) Extreme Long Life
6401296 PUSHER / STR. BLADE	LOW PROFILE 12V 130W			

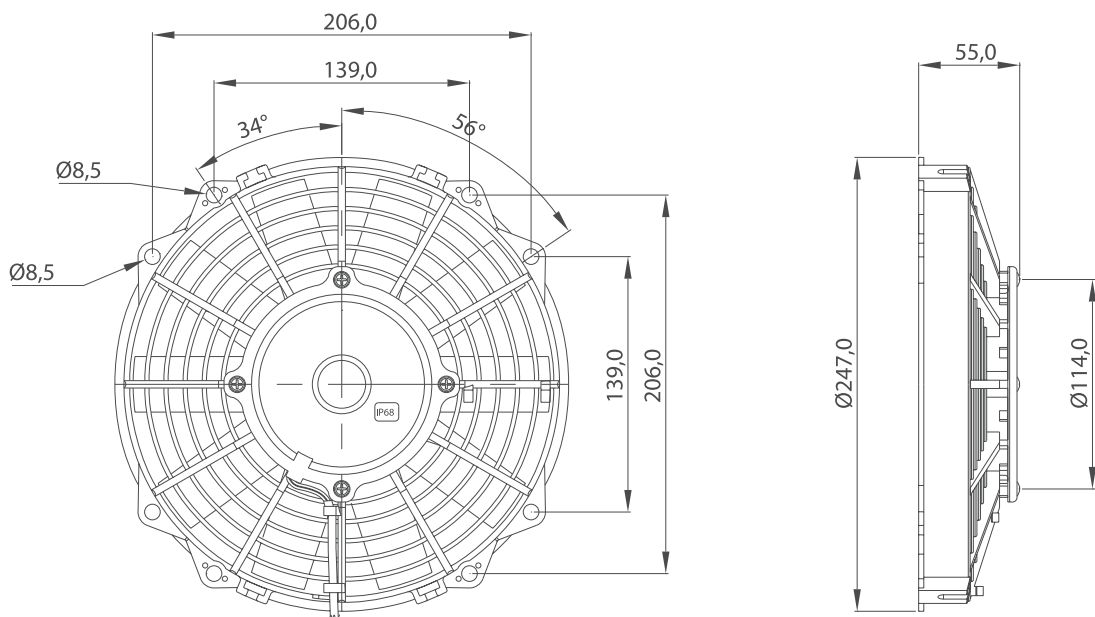

Test Voltage	V	13,0
Nominal Current	A	6,5
Nominal Speed	rpm	3.400
Max. St. Pressure	mmH ₂ O	27,5
Max. Airflow	m ³ /h	1.060
Weight	kg	1,3



All dimensions are in mm.

TEST VOLTAGE = 13,0 VDC	Static Pressure	Air Flow Rate	Current
	mm H ₂ O	m ³ /h	A
	0,0	1059,6	6,2
	2,5	1004,4	6,4
	5,0	943,1	6,5
	7,5	867,3	6,6
	10,0	756,5	6,7
	12,5	595,7	6,7
	15,0	429,0	6,6
	17,5	312,8	6,7
20,0	235,1	6,8	
27,2	0,0	7,4	

Static Pressure: 1 mm H₂O = 0,04in H₂O = 9,8 Pa
Air Flow Rate: 1 m³/h = 0,59 cfm

