

Part Numbers	Specifications	Applications	Features	Options
6402203 PULLER / S BLADE	DIAMETER 9" (225 mm)	HVAC Systems	Waterproof, IP68 (LL) Long Life High Efficiency	Mounting brackets EMC (Certified) Thermal Protector (ELL) Extreme Long Life
6402204 PUSHER / S BLADE	LOW PROFILE 24V 130W			

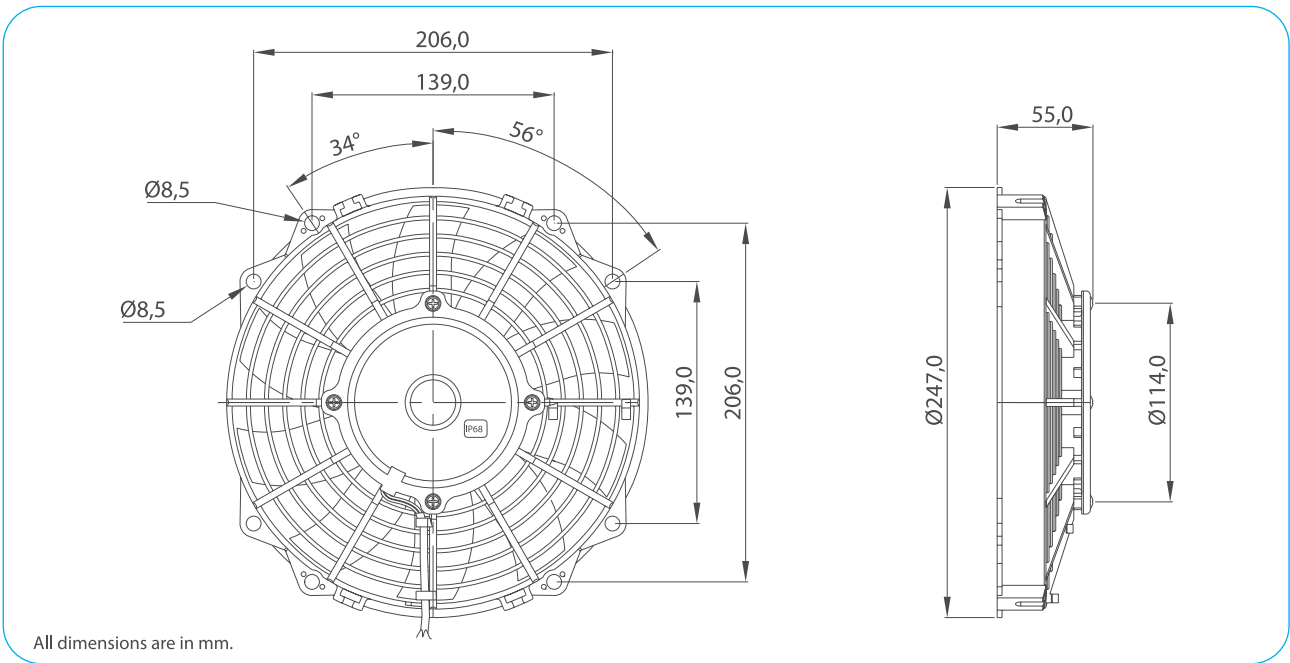

Test Voltage	V	26,0
Nominal Current	A	3,1
Nominal Speed	rpm	3.350
Max. St. Pressure	mmH ₂ O	34,0
Max. Airflow	m ³ /h	1.200
Weight	kg	1,3



TEST VOLTAGE = 26,0 VDC	Static Pressure	Air Flow Rate	Current
	mm H ₂ O	m ³ /h	A
	0,0	1188,9	3,2
	2,5	1150,6	3,4
	5,0	1094,2	3,6
	7,5	1001,8	3,7
	10,0	858,7	3,7
	15,0	545,7	3,7
	20,0	352,4	4,0
	25,0	218,1	4,2
30,0	88,9	4,4	
33,8	0,0	4,6	

Static Pressure: 1 mm H₂O = 0,04in H₂O = 9,8 Pa
Air Flow Rate: 1 m³/h = 0,59 cfm

