

Part Numbers	Specifications	Applications	Features	Options
6403268 PULLER / S BLADE	DIAMETER 10" (255 mm)	HVAC Systems	Waterproof, IP68 (LL) Long Life High Efficiency	Mounting brackets EMC (Certified) Thermal Protector (ELL) Extreme Long Life
6403269 PUSHER / S BLADE	LOW PROFILE 24V 130W			

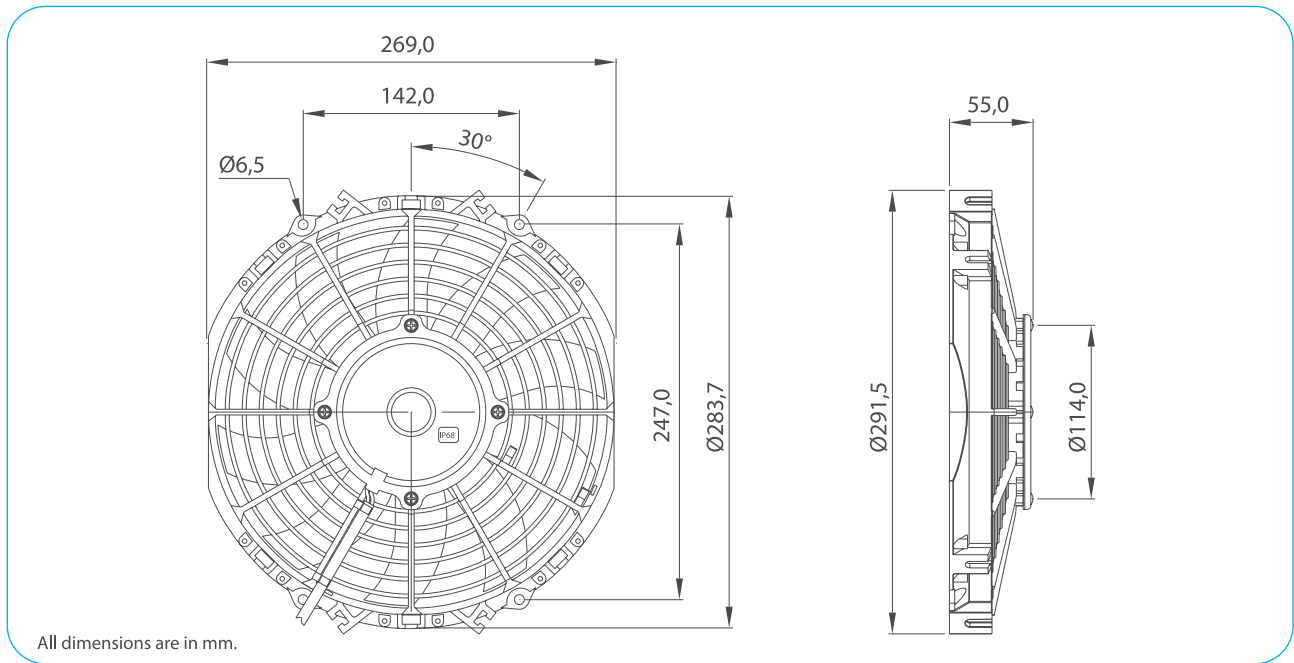

Test Voltage	V	26,0
Nominal Current	A	2,6
Nominal Speed	rpm	2.600
Max. St. Pressure	mmH ₂ O	21,5
Max. Airflow	m ³ /h	1.280
Weight	kg	1,3



TEST VOLTAGE = 26,0 VDC	Static Pressure	Air Flow Rate	Current
	mm H ₂ O	m ³ /h	A
	0,0	1283,2	2,6
	2,5	1215,6	2,8
	5,0	1103,5	2,9
	7,5	916,1	3,0
	10,0	682,5	3,0
	12,5	460,9	3,0
	15,0	298,6	3,1
	17,5	187,0	3,2
21,6	0,0	3,4	

Static Pressure: 1 mm H₂O = 0,04in H₂O = 9,8 Pa
Air Flow Rate: 1 m³/h = 0,59 cfm

