

Part Numbers	Specifications	Applications	Features	Options
6401280 PULLER / S BLADE	DIAMETER 10" (255 mm)	HVAC Systems	Waterproof, IP68 (LL) Long Life High Efficiency	Mounting brackets EMC (Certified) Thermal Protector (ELL) Extreme Long Life
6402213 PUSHER / S BLADE	LOW PROFILE 12V 130W			

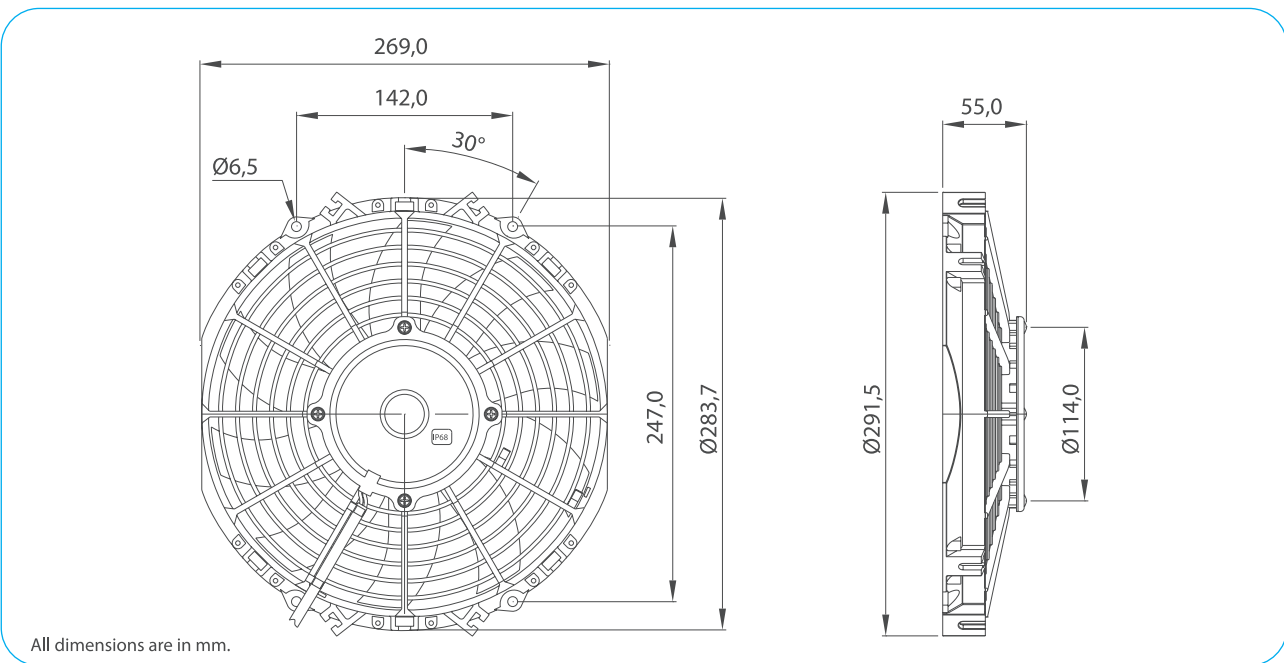

Test Voltage	V	13,0
Nominal Current	A	7,3
Nominal Speed	rpm	2.900
Max. St. Pressure	mmH ₂ O	28,5
Max. Airflow	m ³ /h	1.500
Weight	kg	1,3



TEST VOLTAGE = 13,0 VDC	Static Pressure	Air Flow Rate	Current
	mm H ₂ O	m ³ /h	A
	0,0	1480,2	7,0
	2,5	1390,3	7,4
	5,0	1304,8	7,7
	7,5	1217,5	8,0
	10,0	1076,0	8,2
	12,5	832,6	8,2
	15,0	566,2	8,2
	20,0	301,6	8,6
25,0	138,9	9,1	
28,7	0,0	9,4	

Static Pressure: 1 mm H₂O = 0,04in H₂O = 9,8 Pa
Air Flow Rate: 1 m³/h = 0,59 cfm

