

Part Numbers	Specifications	Applications	Features	Options
6403577 PULLER/STR. BLADE	DIAMETER 10" (255mm)	HVAC Systems	Waterproof, IP68 (LL) Long Life High Efficiency	Mounting brackets EMC (Certified) Thermal Protector (ELL) Extreme Long Life
6403593 PUSHER/STR. BLADE	HIGH PROFILE 24V 225W			

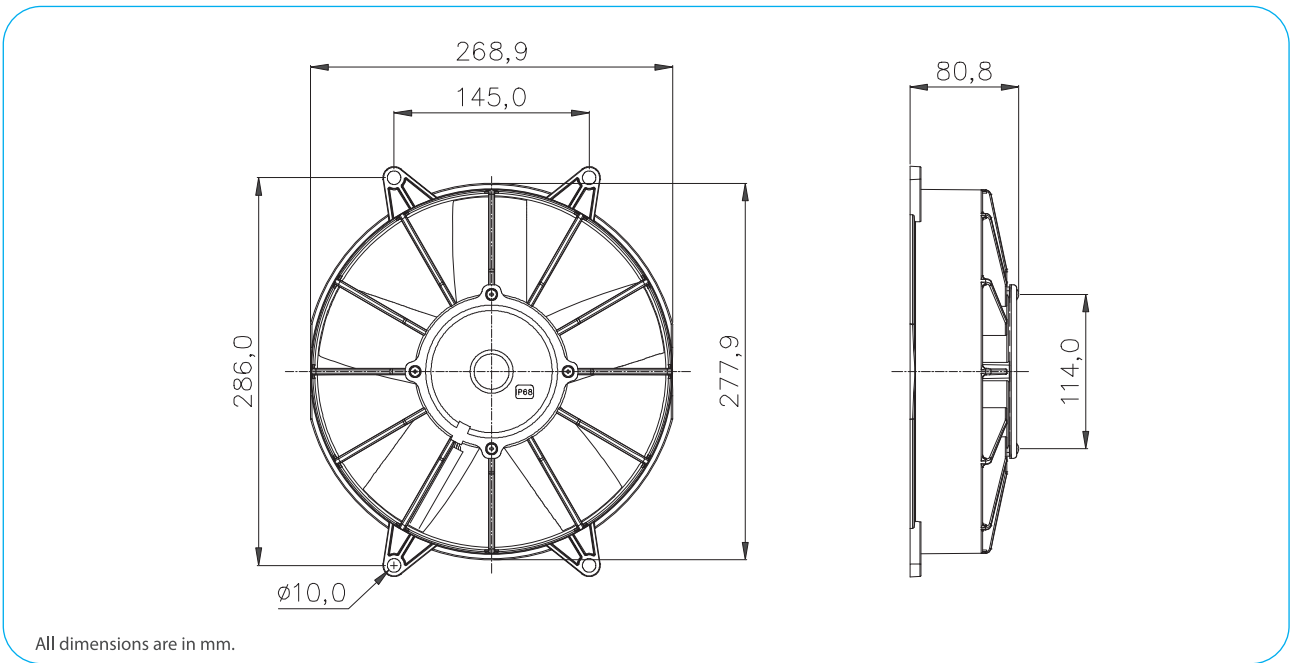

Test Voltage	V	26,0
Nominal Current	A	5,5
Nominal Speed	rpm	3,300
Max. St. Pressure	Pa	440
Max. Airflow	m ³ /h	1.970
Weight	kg	2,1



TEST VOLTAGE = 13,0 VDC

Static Pressure	Air Flow Rate	Current
mm H ₂ O	m ³ /h	A
0,0	1971,5	4,5
2,5	1896,2	4,5
5,0	1811,8	4,4
10,0	1599,8	4,2
15,0	1297,5	4,0
20,0	957,0	3,7
25,0	715,6	3,4
30,0	534,0	3,0
40,0	168,1	2,6
44,5	0,0	2,1

Static Pressure: 1 mm H₂O = 0,04in H₂O = 9,8 Pa
Air Flow Rate: 1 m³/h = 0,59 cfm

