

Part Numbers	Specifications	Applications	Features	Options
6402226 PULLER / S BLADE	DIAMETER 11" (280 mm)	HVAC Systems	Waterproof, IP68 (LL) Long Life High Efficiency	Mounting brackets EMC (Certified) Thermal Protector (ELL) Extreme Long Life
6402227 PUSHER / S BLADE	LOW PROFILE 24V 130W			

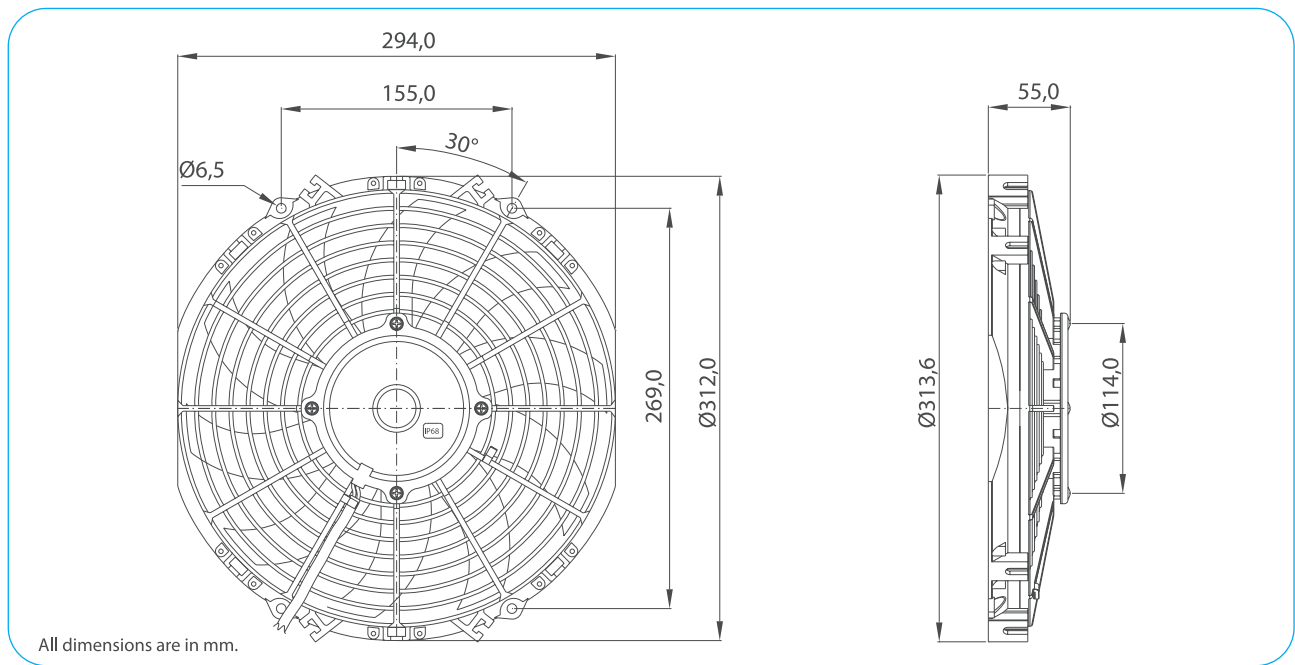

Test Voltage	V	26,0
Nominal Current	A	3,0
Nominal Speed	rpm	2.540
Max. St. Pressure	mmH ₂ O	19,5
Max. Airflow	m ³ /h	1.530
Weight	kg	1,4



TEST VOLTAGE = 26,0 VDC	Static Pressure	Air Flow Rate	Current
	mm H ₂ O	m ³ /h	A
	0,0	1527,5	2,9
	2,5	1412,9	3,0
	5,0	1239,4	3,2
	7,5	981,2	3,3
	10,0	677,6	3,3
	12,5	422,4	3,3
	15,0	263,5	3,5
	19,6	0,0	3,7

Static Pressure: 1 mm H₂O = 0,04in H₂O = 9,8 Pa
Air Flow Rate: 1 m³/h = 0,59 cfm

