

Part Numbers	Specifications	Applications	Features	Options
6402229 PULLER / S BLADE	DIAMETER 11" (280 mm)	HVAC Systems	Waterproof, IP68 (LL) Long Life High Efficiency	Mounting brackets EMC (Certified) Thermal Protector (ELL) Extreme Long Life
6402230 PUSHER / S BLADE	LOW PROFILE 24V 130W			

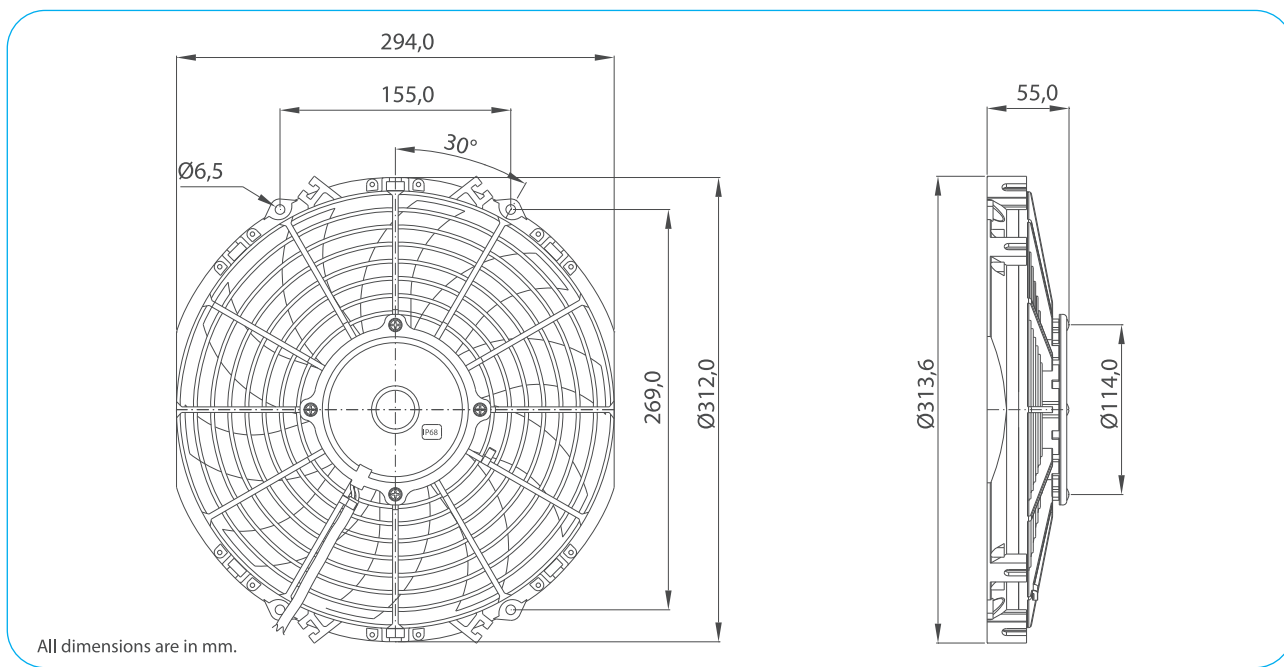

Test Voltage	V	26,0
Nominal Current	A	3,7
Nominal Speed	rpm	2.760
Max. St. Pressure	mmH ₂ O	24,5
Max. Airflow	m ³ /h	1.720
Weight	kg	1,4



TEST VOLTAGE = 26,0 VDC	Static Pressure	Air Flow Rate	Current
	mm H ₂ O	m ³ /h	A
	0,0	1718,8	3,8
	2,5	1621,9	4,0
	5,0	1495,0	4,2
	7,5	1314,0	4,3
	10,0	1079,1	4,4
	12,5	796,0	4,4
	15,0	532,9	4,4
	17,5	357,4	4,5
20,0	239,3	4,6	
24,7	0,0	5,0	

Static Pressure: 1 mm H₂O = 0,04in H₂O = 9,8 Pa
Air Flow Rate: 1 m³/h = 0,59 cfm

