

Part Numbers	Specifications	Applications	Features	Options
6402231 PULLER / STR. BLADE	DIAMETER 11" (280 mm)	HVAC Systems	Waterproof, IP68 (LL) Long Life High Efficiency	Mounting brackets EMC (Certified) Thermal Protector (ELL) Extreme Long Life
6402232 PUSHER / STR. BLADE	LOW PROFILE 12V 160W			

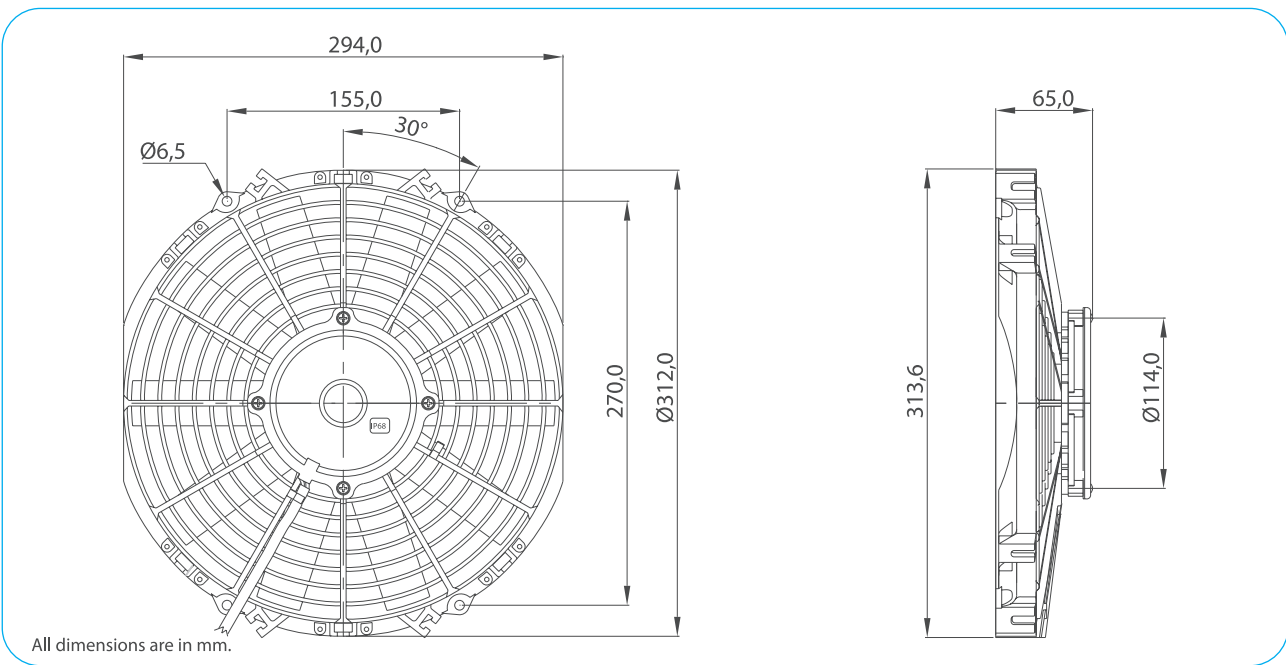

Test Voltage	V	13,0
Nominal Current	A	7,8
Nominal Speed	rpm	3.120
Max. St. Pressure	mmH ₂ O	26,5
Max. Airflow	m ³ /h	1.650
Weight	kg	1,7



TEST VOLTAGE = 13,0 VDC	Static Pressure	Air Flow Rate	Current
	mm H ₂ O	m ³ /h	A
	0,0	1635,6	7,7
	2,5	1576,2	7,9
	5,0	1495,6	8,2
	7,5	1378,5	8,6
	10,0	1206,6	8,8
	12,5	978,5	8,7
	15,0	745,4	8,5
	17,5	550,6	8,5
20,0	390,6	8,6	
26,4	0,0	8,7	

Static Pressure: 1 mm H₂O = 0,04 in H₂O = 9,8 Pa
Air Flow Rate: 1 m³/h = 0,59 cfm

