

Part Numbers	Specifications	Applications	Features	Options
6403385 PULLER / STR. BLADE	DIAMETER 11" (280 mm)	HVAC Systems	Waterproof, IP68 (LL) Long Life High Efficiency	Mounting brackets EMC (Certified) Thermal Protector (ELL) Extreme Long Life
6402285 PUSHER / STR. BLADE	HIGH PROFILE 12V 225W			

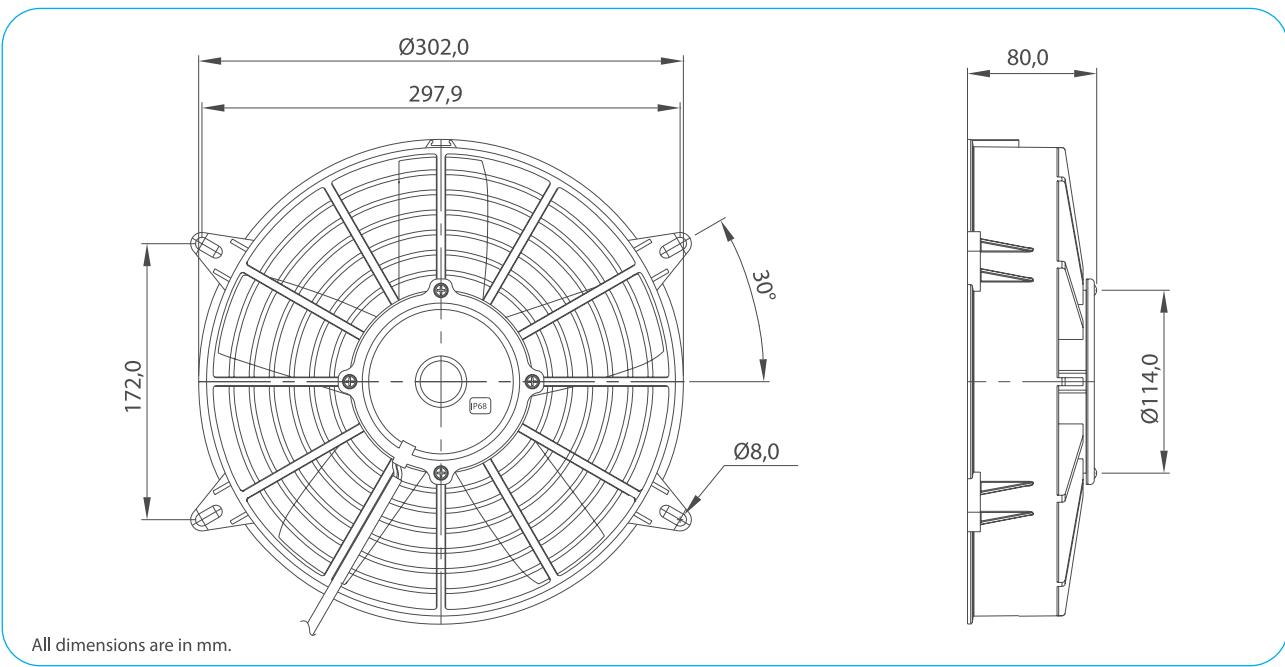

Test Voltage	V	13,0
Nominal Current	A	14,0
Nominal Speed	rpm	3.080
Max. St. Pressure	mmH ₂ O	37,5
Max. Airflow	m ³ /h	2.230
Weight	kg	2,3



TEST VOLTAGE = 13,0 VDC

Static Pressure	Air Flow Rate	Current
mm H ₂ O	m ³ /h	A
0,0	2214,7	13,5
2,5	2197,0	13,6
5,0	2116,4	13,8
7,5	1926,6	14,2
10,0	1655,7	14,5
15,0	1092,9	14,7
20,0	810,8	15,8
25,0	596,1	16,3
30,0	363,7	17,2
37,4	0,0	19,2

Static Pressure: 1 mm H₂O = 0,04in H₂O = 9,8 Pa
Air Flow Rate: 1 m³/h = 0,59 cfm

