

Part Numbers	Specifications	Applications	Features	Options
6402235 PULLER / STR. BLADE	DIAMETER 12" (305 mm)	HVAC Systems	Waterproof, IP68 (LL) Long Life High Efficiency	Mounting brackets EMC (Certified) Thermal Protector (ELL) Extreme Long Life
6402236 PUSHER / STR. BLADE	LOW PROFILE 12V 130W			

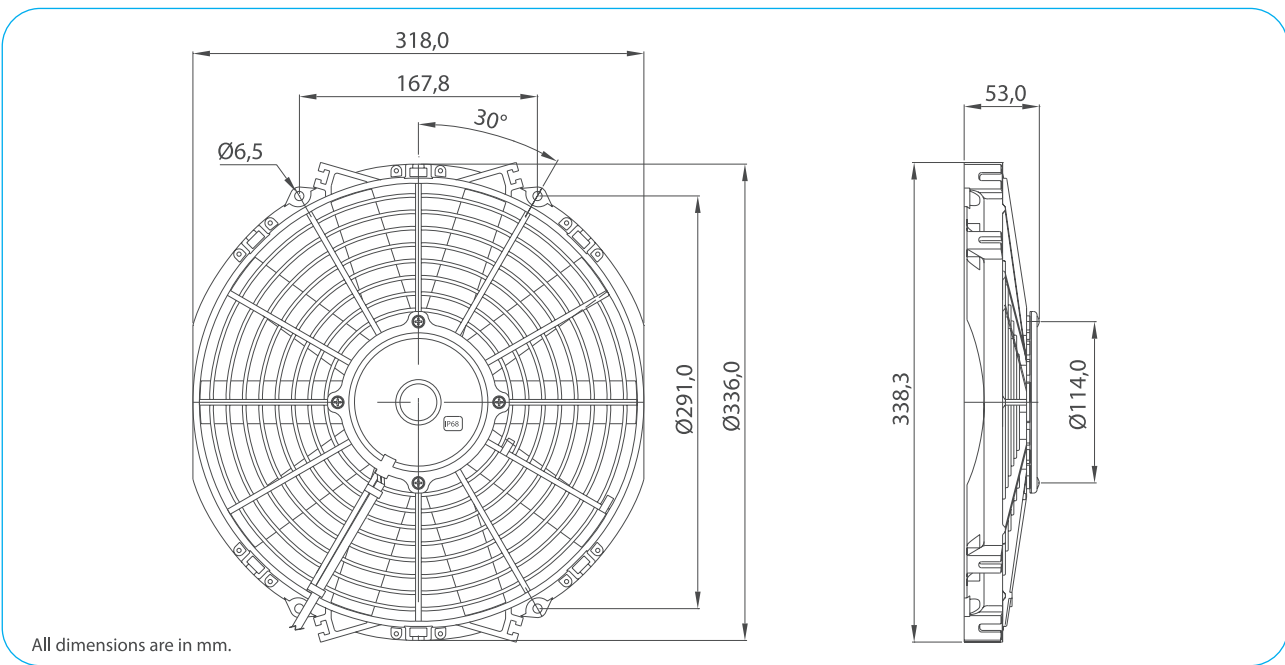

Test Voltage	V	13,0
Nominal Current	A	5,4
Nominal Speed	rpm	2.550
Max. St. Pressure	mmH ₂ O	18,0
Max. Airflow	m ³ /h	1.510
Weight	kg	1,5



TEST VOLTAGE = 13,0 VDC	Static Pressure	Air Flow Rate	Current
	mm H ₂ O	m ³ /h	A
	0,0	1511,2	5,3
	2,5	1380,4	5,8
	5,0	1217,2	6,0
	7,5	988,2	6,1
	10,0	706,8	6,2
	12,5	451,1	6,1
	15,0	234,8	6,0
	18,1	0,0	6,0

Static Pressure: 1 mm H₂O = 0,04in H₂O = 9,8 Pa
Air Flow Rate: 1 m³/h = 0,59 cfm

