

Part Numbers	Specifications	Applications	Features	Options
6402243 PULLER / STR. BLADE	DIAMETER 12" (305 mm)	HVAC Systems	Waterproof, IP68 (LL) Long Life High Efficiency	Mounting brackets EMC (Certified) Thermal Protector (ELL) Extreme Long Life
6401251 PUSHER / STR. BLADE	LOW PROFILE 12V 160W			

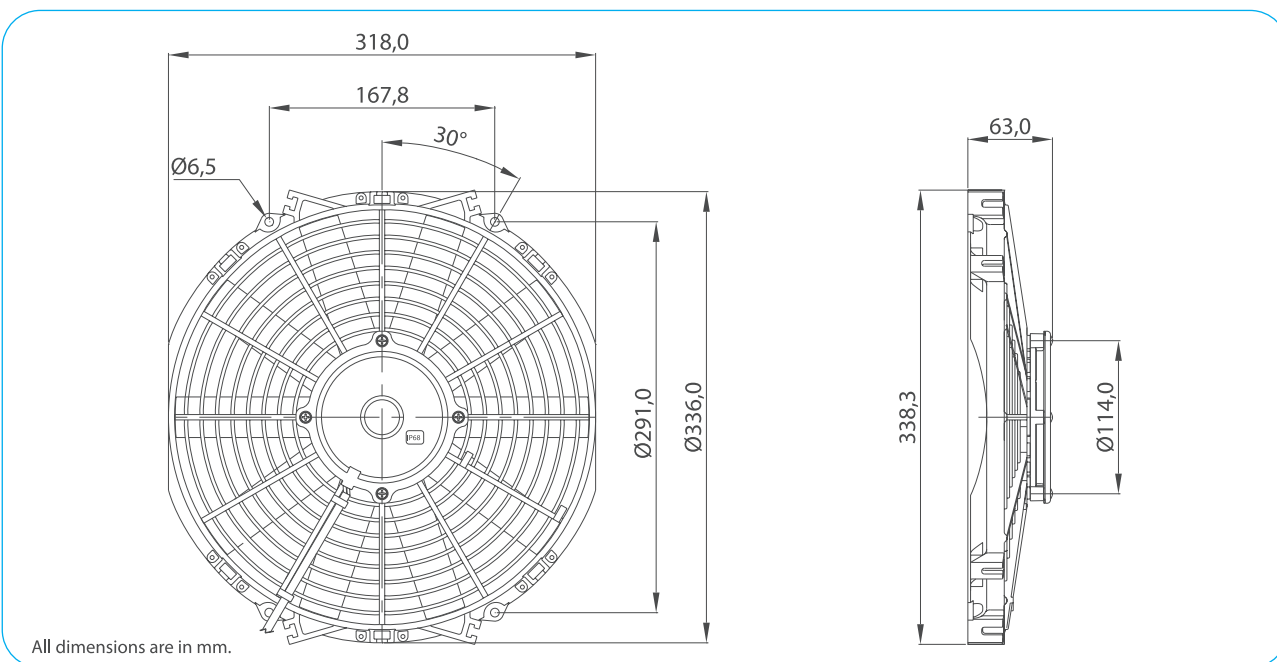

Test Voltage	V	13,0
Nominal Current	A	12,0
Nominal Speed	rpm	3.470
Max. St. Pressure	mmH ₂ O	33,0
Max. Airflow	m ³ /h	2.180
Weight	kg	1,8



TEST VOLTAGE = 13,0 VDC	Static Pressure	Air Flow Rate	Current
	mm H ₂ O	m ³ /h	A
	0,0	2179,9	11,6
	2,5	2096,3	12,1
	5,0	2005,3	12,6
	7,5	1903,3	13,0
	10,0	1780,7	13,4
	15,0	1403,7	13,7
	20,0	890,7	13,2
	25,0	506,3	13,1
	30,0	198,5	13,0
	33,3	0,0	12,9

Static Pressure: 1 mm H₂O = 0,04in H₂O = 9,8 Pa
Air Flow Rate: 1 m³/h = 0,59 cfm

