

Part Numbers	Specifications	Applications	Features	Options
6402251 PULLER / S BLADE	DIAMETER 12" (305 mm)	HVAC Systems	Waterproof, IP68 (LL) Long Life High Efficiency	Mounting brackets EMC (Certified) Thermal Protector (ELL) Extreme Long Life
6402252 PUSHER / S BLADE	LOW PROFILE 24V 225W			

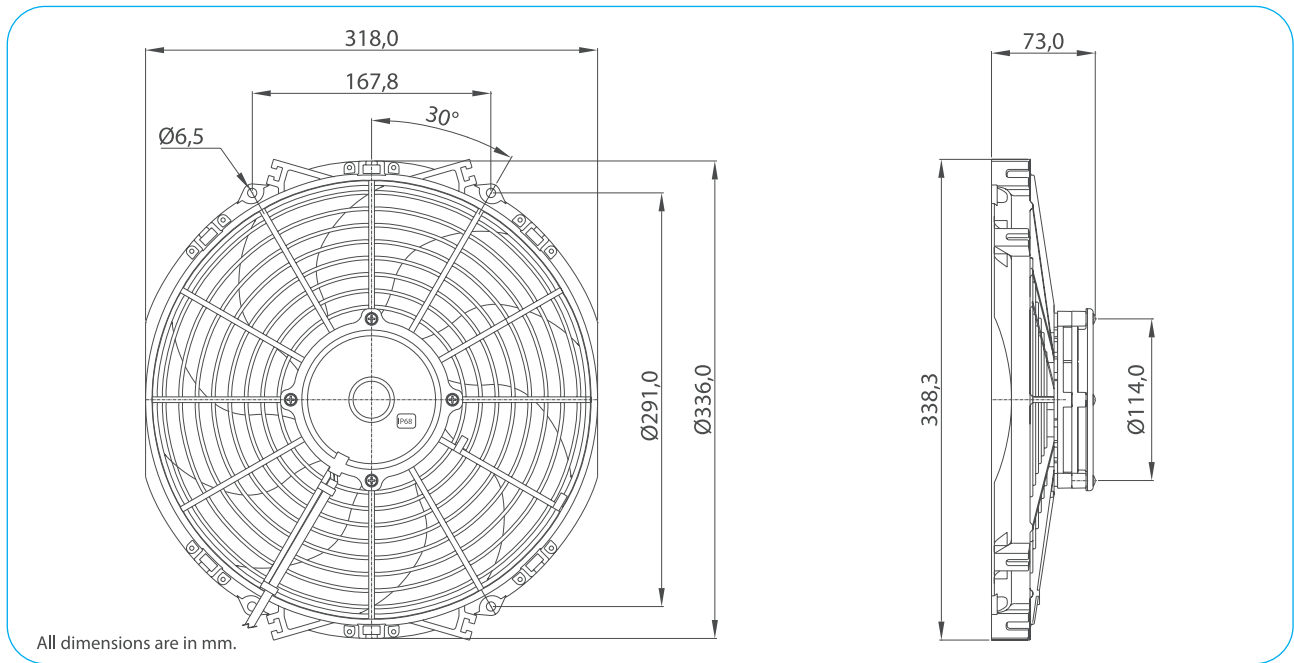

Test Voltage	V	26,0
Nominal Current	A	6,5
Nominal Speed	rpm	3.300
Max. St. Pressure	mmH ₂ O	31,0
Max. Airflow	m ³ /h	2.260
Weight	kg	2,2



TEST VOLTAGE = 26,0 VDC	Static Pressure	Air Flow Rate	Current
	mm H ₂ O	m ³ /h	A
	0,0	2259,4	6,3
	2,5	2167,7	6,4
	5,0	2080,1	6,6
	7,5	1989,4	6,9
	10,0	1813,7	7,1
	15,0	1090,5	6,8
	20,0	720,4	7,1
	25,0	376,3	7,5
30,0	58,9	8,1	
31,0	0,0	8,2	

Static Pressure: 1 mm H₂O = 0,04in H₂O = 9,8 Pa
Air Flow Rate: 1 m³/h = 0,59 cfm

