

Part Numbers	Specifications	Applications	Features	Options
<b>6401224</b> PULLER / STR. BLADE	<b>DIAMETER 16" (385 mm)</b>	HVAC Systems	Waterproof, IP68 (LL) Long Life High Efficiency	Mounting brackets EMC (Certified) Thermal Protector (ELL) Extreme Long Life
<b>6401238</b> PUSHER / STR. BLADE	<b>LOW PROFILE</b> <b>24V 130W</b>			

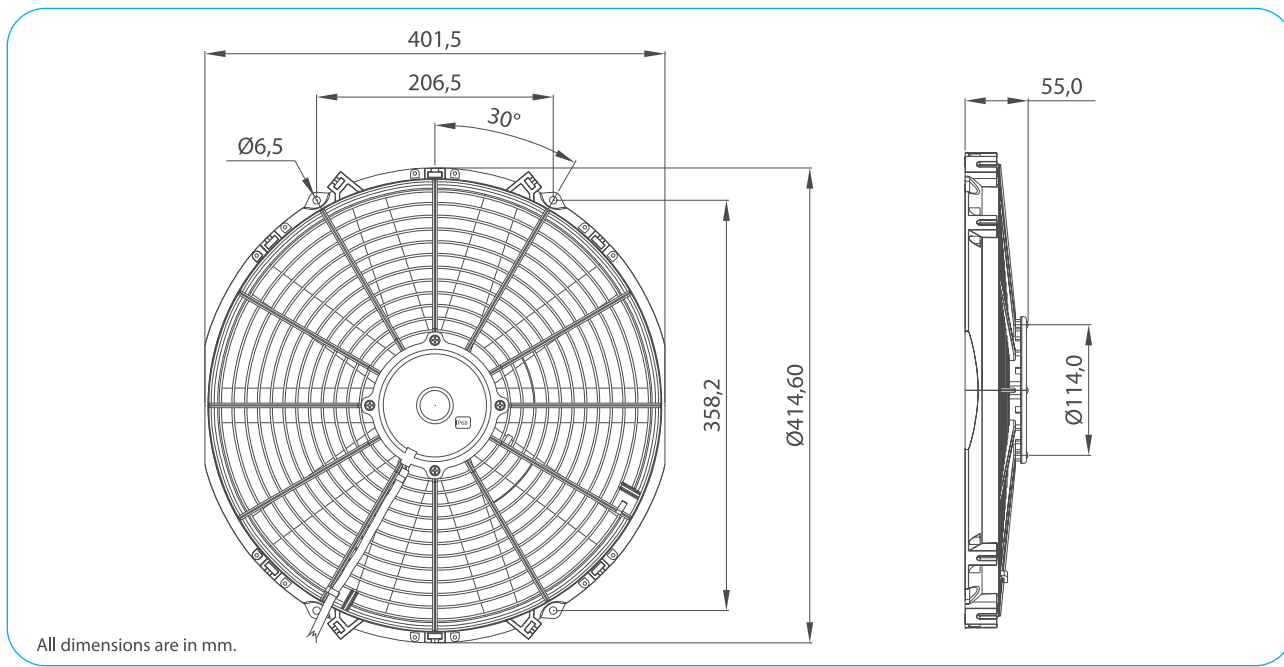

Test Voltage	V	26,0
Nominal Current	A	4,0
Nominal Speed	rpm	2.360
Max. St. Pressure	mmH <sub>2</sub> O	17,5
Max. Airflow	m <sup>3</sup> /h	2.185
Weight	kg	1,6



TEST VOLTAGE = 26,0 VDC	Static Pressure	Air Flow Rate	Current
	mm H <sub>2</sub> O	m <sup>3</sup> /h	A
	0,0	2183,5	3,9
	2,5	1944,3	4,2
	5,0	1680,1	4,4
	7,5	1361,1	4,4
	10,0	963,8	4,4
	12,5	595,8	4,3
	15,0	284,1	12,9
17,3	0,0	4,2	

Static Pressure: 1 mm H<sub>2</sub>O = 0,04in H<sub>2</sub>O = 9,8 Pa  
Air Flow Rate: 1 m<sup>3</sup>/h = 0,59 cfm

