

Part Numbers	Specifications	Applications	Features	Options
6402267 PULLER / STR. BLADE	DIAMETER 16" (385 mm)	HVAC Systems	Waterproof, IP68 (LL) Long Life High Efficiency	Mounting brackets EMC (Certified) Thermal Protector (ELL) Extreme Long Life
6401262 PUSHER / STR. BLADE	LOW PROFILE 24V 225W			

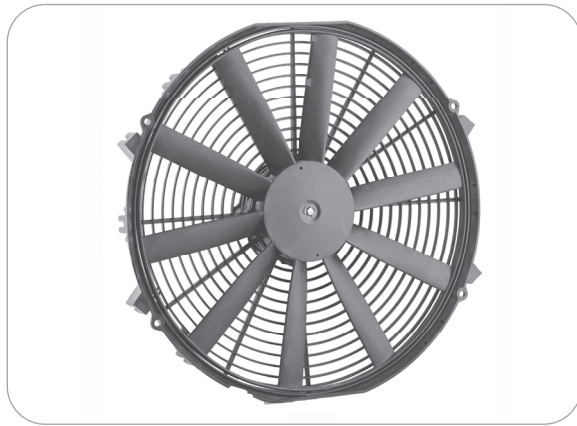

Test Voltage	V	26,0
Nominal Current	A	7,0
Nominal Speed	rpm	3.090
Max. St. Pressure	mmH ₂ O	28,0
Max. Airflow	m ³ /h	2.860
Weight	kg	2,3

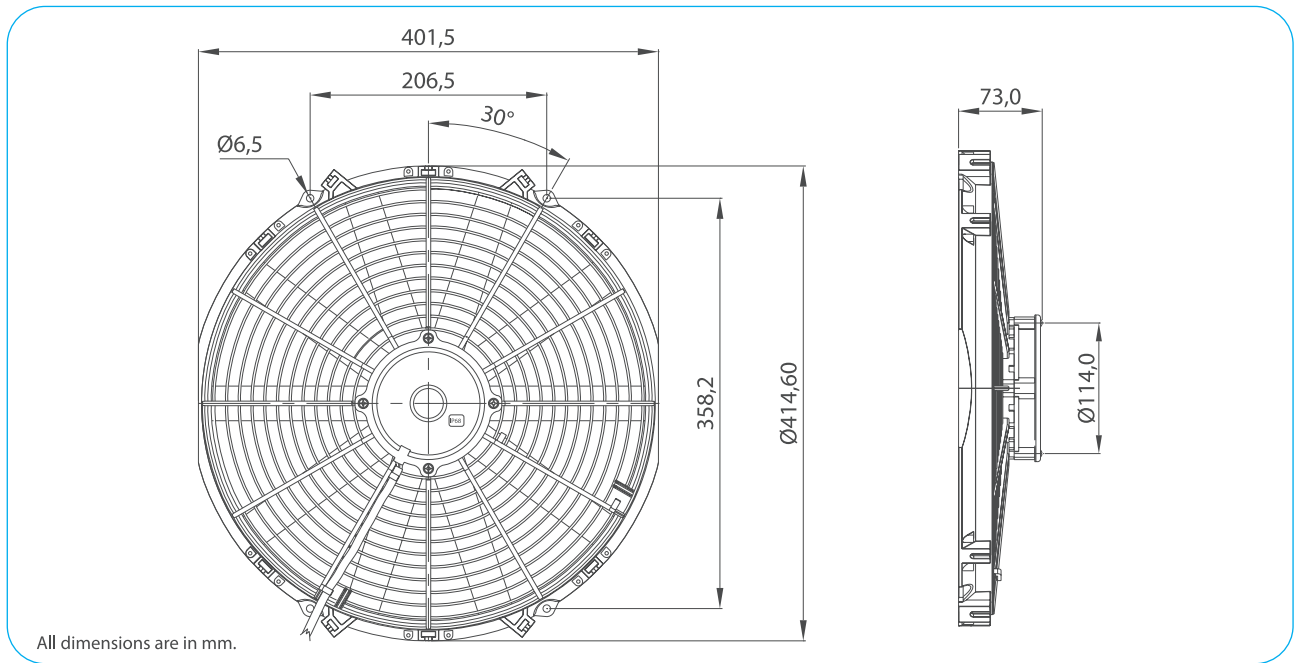

TEST VOLTAGE = 26,0 VDC	Static Pressure	Air Flow Rate	Current
	mm H ₂ O	m ³ /h	A
	0,0	2863,6	7,0
	2,5	2707,8	7,3
	5,0	2548,2	7,6
	7,5	2376,0	7,7
	10,0	2158,5	7,8
	12,5	1866,1	7,8
	15,0	1531,5	7,7
	20,0	920,5	7,4
25,0	363,1	7,1	
28,2	0,0	7,0	

Static Pressure: 1 mm H₂O = 0,04in H₂O = 9,8 Pa
Air Flow Rate: 1 m³/h = 0,59 cfm

