

Part Numbers	Specifications	Applications	Features	Options
6403283 PUSHER / PULLER	DIAMETER 9" (225 mm) LOW PROFILE 12V 130W	HVAC Systems	Waterproof, IP68 (LL) Long Life Reversible Airflow High Efficiency	Mounting brackets EMC (Certified) Thermal Protector (ELL) Extreme Long Life

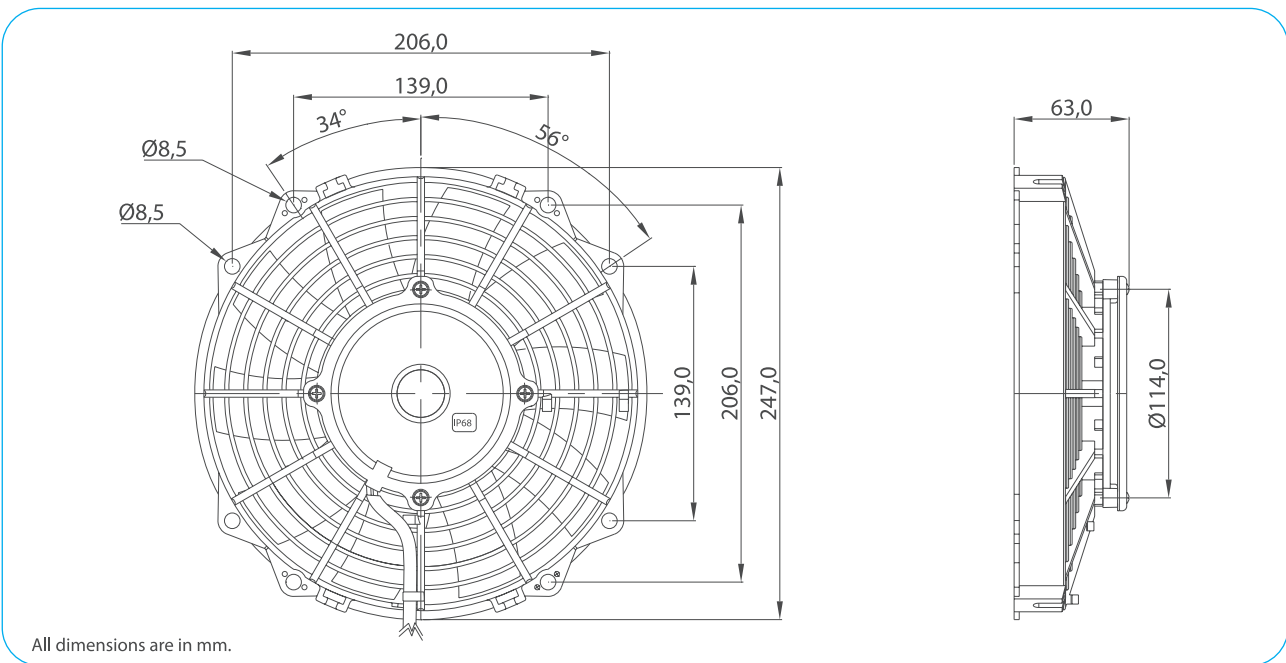

Test Voltage	V	13,0
Nominal Current	A	8,2
Nominal Speed	rpm	3.250
Max. St. Pressure	mmH ₂ O	27,0
Max. Airflow	m ³ /h	1.200
Weight	kg	1,4



TEST VOLTAGE = 13,0 VDC	Static Pressure	Air Flow Rate	Current
	mm H ₂ O	m ³ /h	A
	0,0	1196,8	8,0
	2,5	1115,8	7,8
	5,0	1027,2	7,7
	7,5	927,4	7,7
	10,0	799,4	7,8
	12,5	638,3	7,8
	15,0	475,9	7,9
	20,0	286,0	8,2
25,0	89,8	9,0	
27,0	0,0	9,4	

Static Pressure: 1 mm H₂O = 0,04 in H₂O = 9,8 Pa
Air Flow Rate: 1 m³/h = 0,59 cfm

