

Part Numbers	Specifications	Applications	Features	Options
6403319 PUSHER / PULLER	DIAMETER 14" (350 mm) LOW PROFILE 24V 160W	HVAC Systems	Waterproof, IP68 (LL) Long Life Reversible Airflow High Efficiency	Mounting brackets EMC (Certified) Thermal Protector (ELL) Extreme Long Life

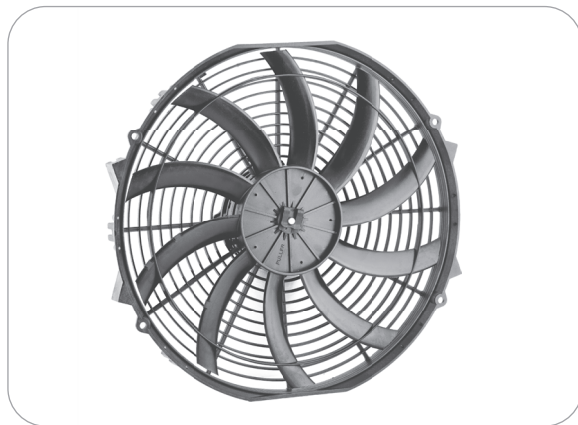

Test Voltage	V	26,0
Nominal Current	A	3,7
Nominal Speed	rpm	2.200
Max. St. Pressure	mmH ₂ O	15,5
Max. Airflow	m ³ /h	2.360
Weight	kg	2,0

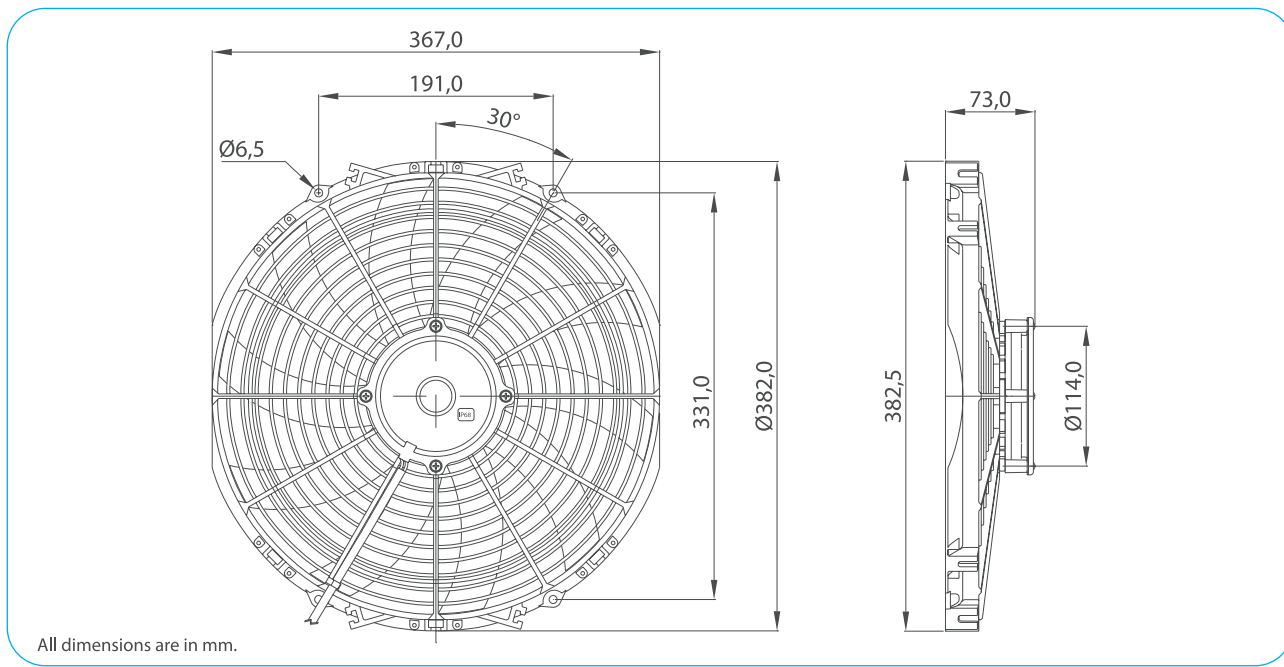

TEST VOLTAGE = 26,0 VDC	Static Pressure	Air Flow Rate	Current
	mm H ₂ O	m ³ /h	A
	0,0	2360,8	3,7
	2,5	2152,4	3,8
	5,0	1933,6	4,1
	7,5	1623,6	4,2
	10,0	1118,5	3,9
	12,5	578,6	3,8
	15,5	0,0	4,0

Static Pressure: 1 mm H₂O = 0,04in H₂O = 9,8 Pa
Air Flow Rate: 1 m³/h = 0,59 cfm

