

Part Numbers	Specifications	Applications	Features	Options
6401557 ONE SPEED	WIDTH 325 mm 850 m³/h 12V	HVAC Systems	High Pressure Silent Operation High Efficiency	Speed Control EMC (Certified) Thermal Protector (LL) Long Life Version

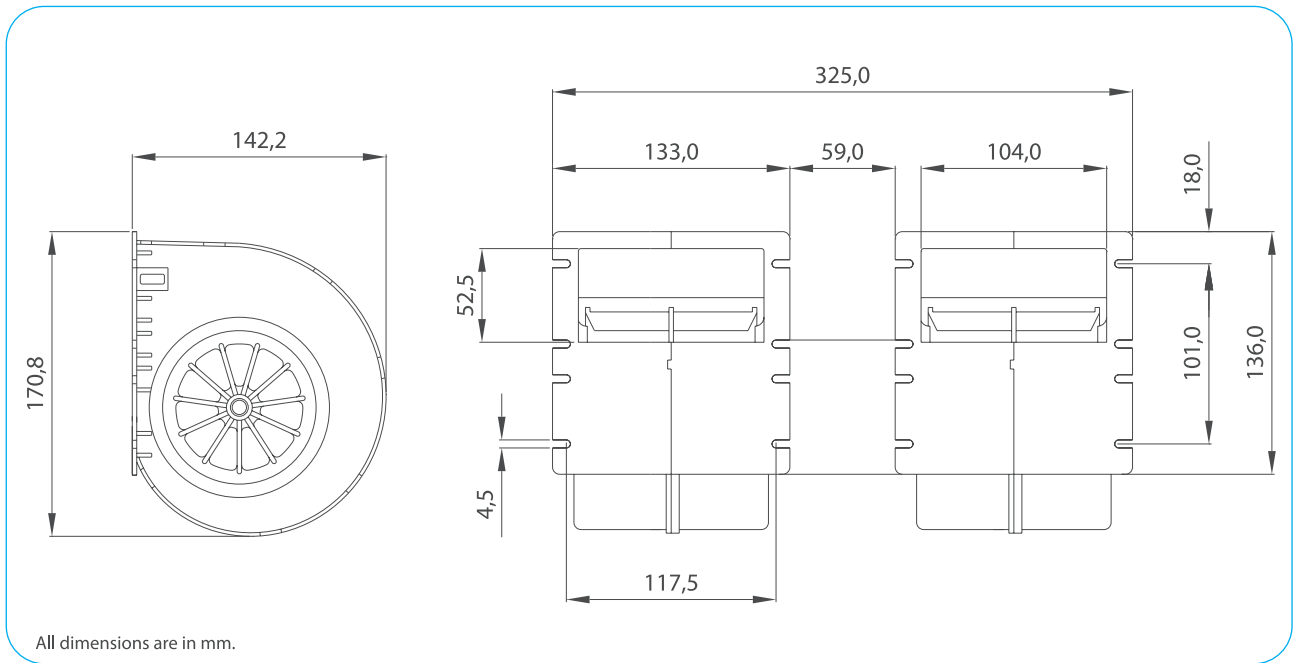

Test Voltage	V	13,0
Nominal Current	A	15,5
Nominal Speed	rpm	2.900
Max. St. Pressure	mmH ₂ O	52,0
Max. Airflow	m ³ /h	850
Weight	kg	2,2



TEST VOLTAGE = 13,0 VDC	Static Pressure	Air Flow Rate	Current
	mm H ₂ O	m ³ /h	A
	0,0	851,9	15,1
	5,0	810,9	14,4
	10,0	768,1	13,7
	15,0	722,6	13,1
	20,0	674,1	12,5
	25,0	617,9	11,7
	30,0	548,3	10,5
	35,0	457,7	9,0
40,0	345,9	7,5	
51,9	0,0	4,8	

Static Pressure: 1 mm H₂O = 0,04 in H₂O = 9,8 Pa
Air Flow Rate: 1 m³/h = 0,59 cfm

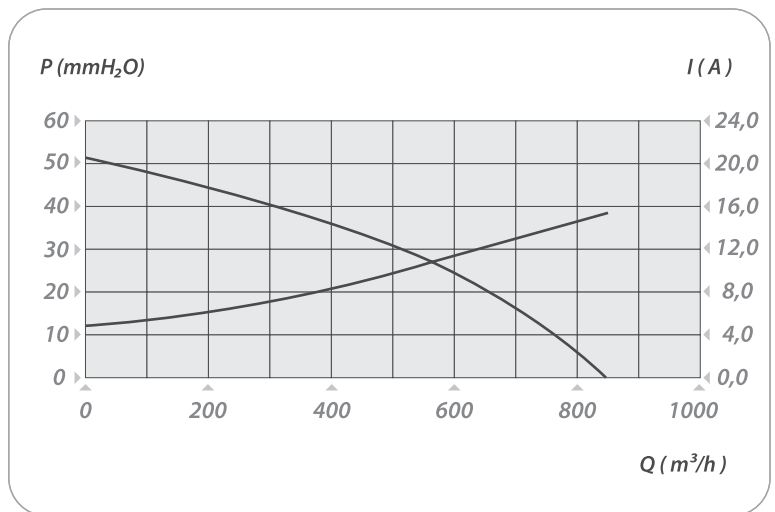
2 X SINGLE BLOWERS