

Part Numbers	Specifications	Applications	Features	Options
6401544 THREE SPEED	WIDTH 325 mm 850 m³/h 24V	HVAC Systems	High Pressure Silent Operation High Efficiency	PWM Speed Control EMC (Certified) Thermal Protector (LL) Long Life Version

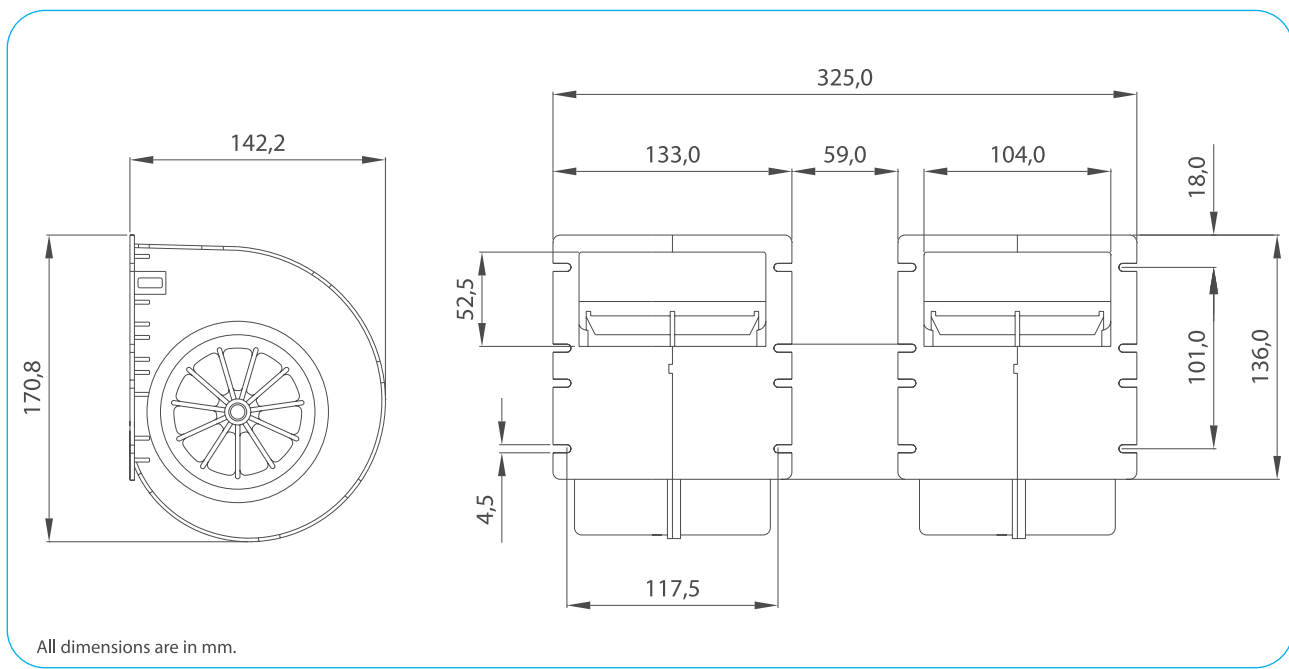

Test Voltage	V	26,0
Nominal Current	A	7,5
Nominal Speed	rpm	2.900
Max. St. Pressure	mmH ₂ O	50,0
Max. Airflow	m ³ /h	850
Weight	kg	2,3
Airflow Rates	%	100-76-64



TEST VOLTAGE = 26,0 VDC	Static Pressure	Air Flow Rate	Current
	mm H ₂ O	m ³ /h	A
	0,0	855,0	7,5
	5,0	820,8	7,3
	10,0	782,0	7,0
	15,0	733,5	6,7
	20,0	684,0	6,4
	25,0	637,4	6,1
	30,0	552,9	5,4
	35,0	459,5	4,7
	40,0	344,6	3,6
	50,0	0,0	0,0

Static Pressure: 1 mm H₂O = 0,04in H₂O = 9,8 Pa
Air Flow Rate: 1 m³/h = 0,59 cfm

