

Part Numbers	Specifications	Applications	Features	Options
6401535 ONE SPEED	HEIGHT 128 mm 350 m³/h 12V	HVAC Systems	High Pressure Compact Design High Efficiency	Speed Control EMC (Certified) Thermal Protector

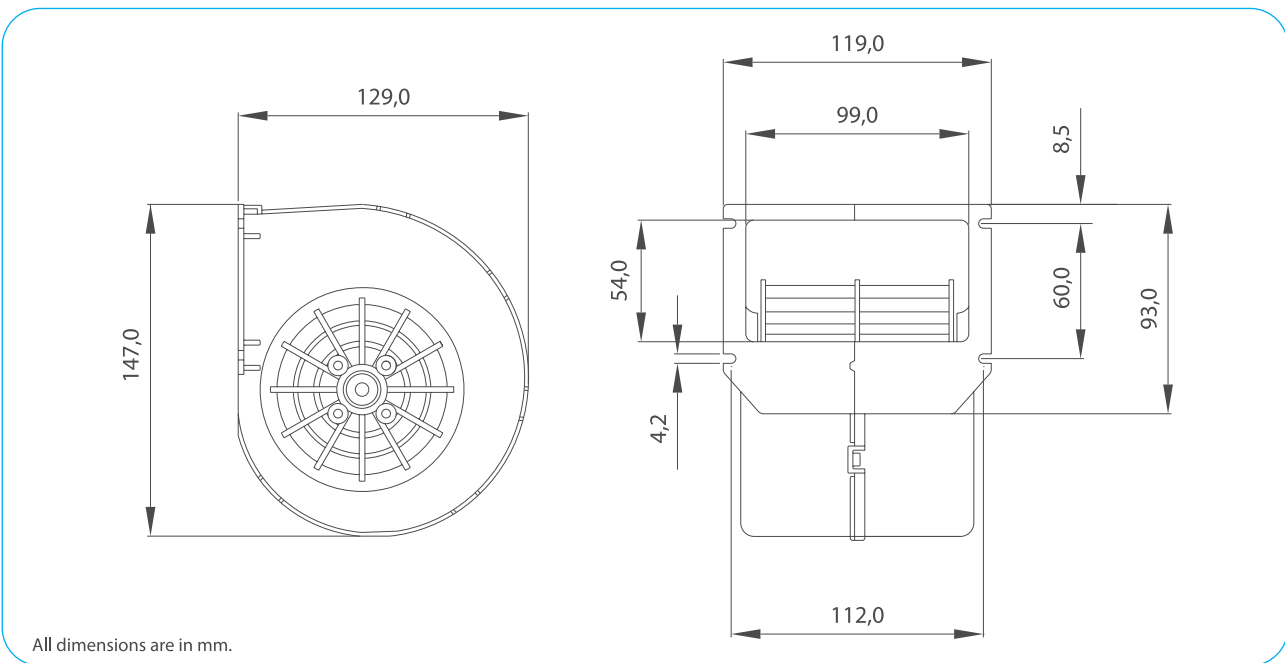

Test Voltage	V	13,0
Nominal Current	A	8,3
Nominal Speed	rpm	3.750
Max. St. Pressure	mmH ₂ O	60,0
Max. Airflow	m ³ /h	340
Weight	kg	0,7



TEST VOLTAGE = 13,0 VDC	Static Pressure	Air Flow Rate	Current
	mm H ₂ O	m ³ /h	A
	0,0	338,7	8,0
	5,0	323,1	7,7
	10,0	307,0	7,4
	15,0	289,8	7,2
	20,0	271,1	6,9
	30,0	250,9	6,3
	40,0	228,6	5,2
	50,0	170,1	4,0
60,0	90,0	3,0	
59,8	0,0	3,0	

Static Pressure: 1 mm H₂O = 0,04in H₂O = 9,8 Pa
Air Flow Rate: 1 m³/h = 0,59 cfm

