

Part Numbers	Specifications	Applications	Features	Options
6401793 ONE SPEED	HEIGHT 134 mm 400 m³/h 24V	HVAC Systems	High Pressure Compact Design High Efficiency	PWM Speed Control EMC (Certified) Thermal Protector

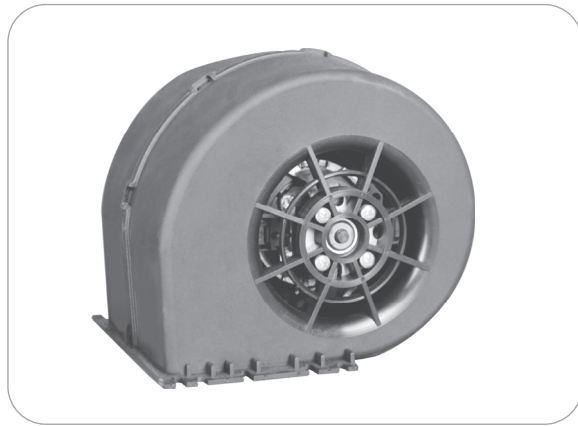

Test Voltage	V	26,0
Nominal Current	A	5,5
Nominal Speed	rpm	3.350
Max. St. Pressure	mmH ₂ O	78,0
Max. Airflow	m ³ /h	390
Weight	kg	0,7

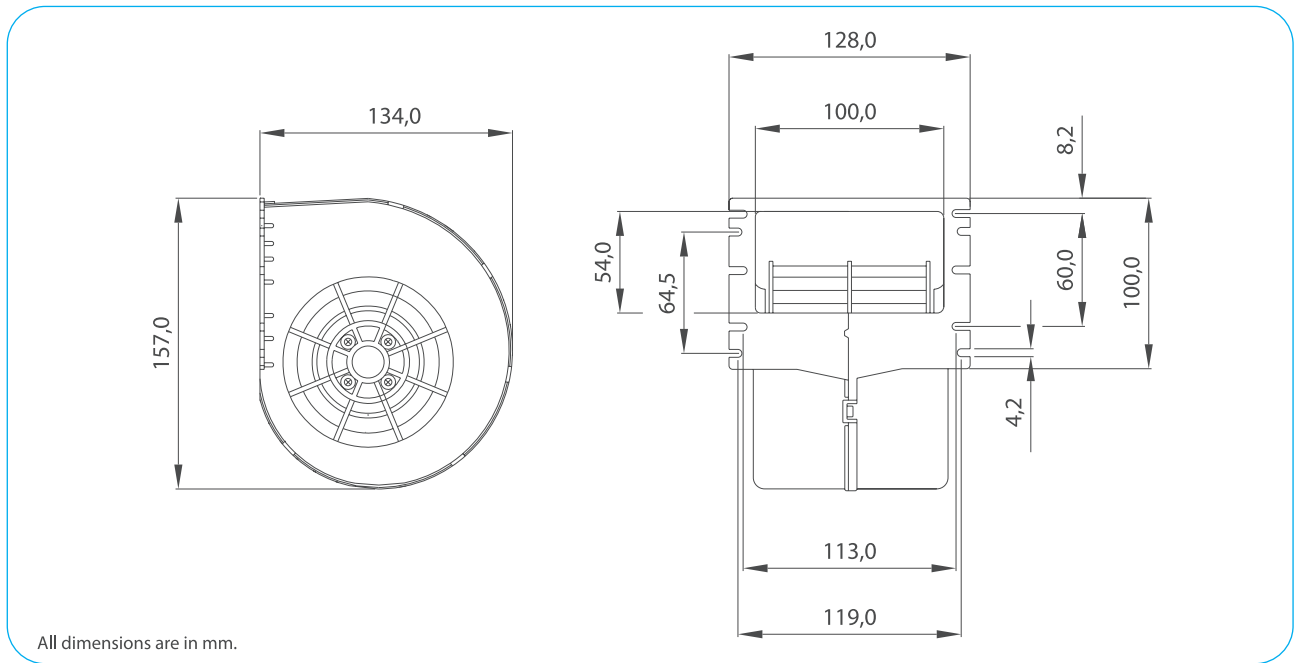

TEST VOLTAGE = 26,0 VDC	Static Pressure	Air Flow Rate	Current
	mm H ₂ O	m ³ /h	A
	0,0	386,1	5,7
	5,0	370,3	5,5
	10,0	354,7	5,4
	20,0	324,9	5,4
	30,0	292,4	4,9
	40,0	250,6	4,6
	50,0	202,2	4,1
	60,0	145,8	3,7
70,0	70,9	3,1	
78,3	0,0	2,6	

Static Pressure: 1 mm H₂O = 0,04in H₂O = 9,8 Pa
Air Flow Rate: 1 m³/h = 0,59 cfm

