

Part Numbers	Specifications	Applications	Features	Options
6403485 PULLER / S BLADE	DIAMETER 9" (225 mm)	HVAC Systems	Waterproof, IP68 (LL) Long Life High Efficiency	Mounting brackets EMC (Certified) Thermal Protector (ELL) Extreme Long Life
6403486 PUSHER / S BLADE	LOW PROFILE 24V 130W			

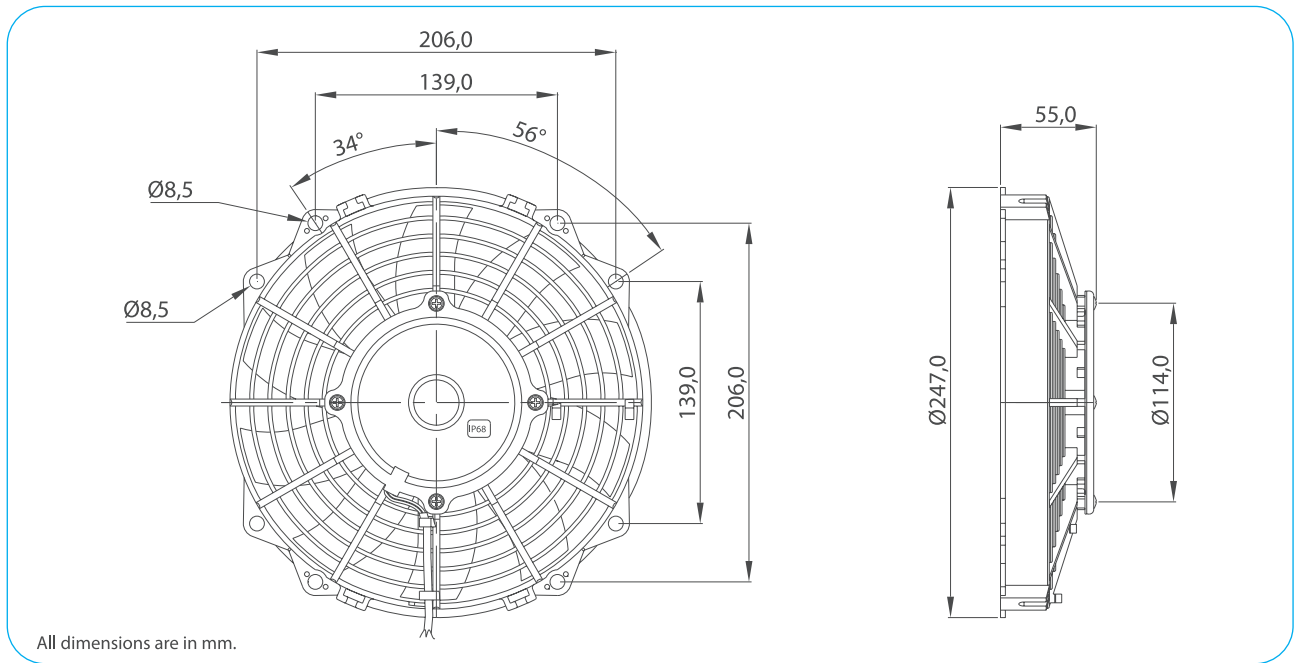

Test Voltage	V	26,0
Nominal Current	A	1,5
Nominal Speed	rpm	2.500
Max. St. Pressure	mmH ₂ O	18,0
Max. Airflow	m ³ /h	810
Weight	kg	1,3



TEST VOLTAGE = 26,0 VDC	Static Pressure	Air Flow Rate	Current
	mm H ₂ O	m ³ /h	A
	0,0	812,7	1,5
	2,5	750,6	1,6
	5,0	608,2	1,7
	7,5	406,9	1,7
	10,0	277,0	1,8
	12,5	184,9	1,9
	15,0	95,8	2,0
	17,5	17,3	2,1
18,1	0,0	2,1	

Static Pressure: 1 mm H₂O = 0,04in H₂O = 9,8 Pa
Air Flow Rate: 1 m³/h = 0,59 cfm

