

Part Numbers	Specifications	Applications	Features	Options
6401297 PULLER / STR. BLADE	DIAMETER 9" (225 mm)	HVAC Systems	Waterproof, IP68 (LL) Long Life High Efficiency	Mounting brackets EMC (Certified) Thermal Protector (ELL) Extreme Long Life
6401298 PUSHER / STR. BLADE	LOW PROFILE 24V 130W			

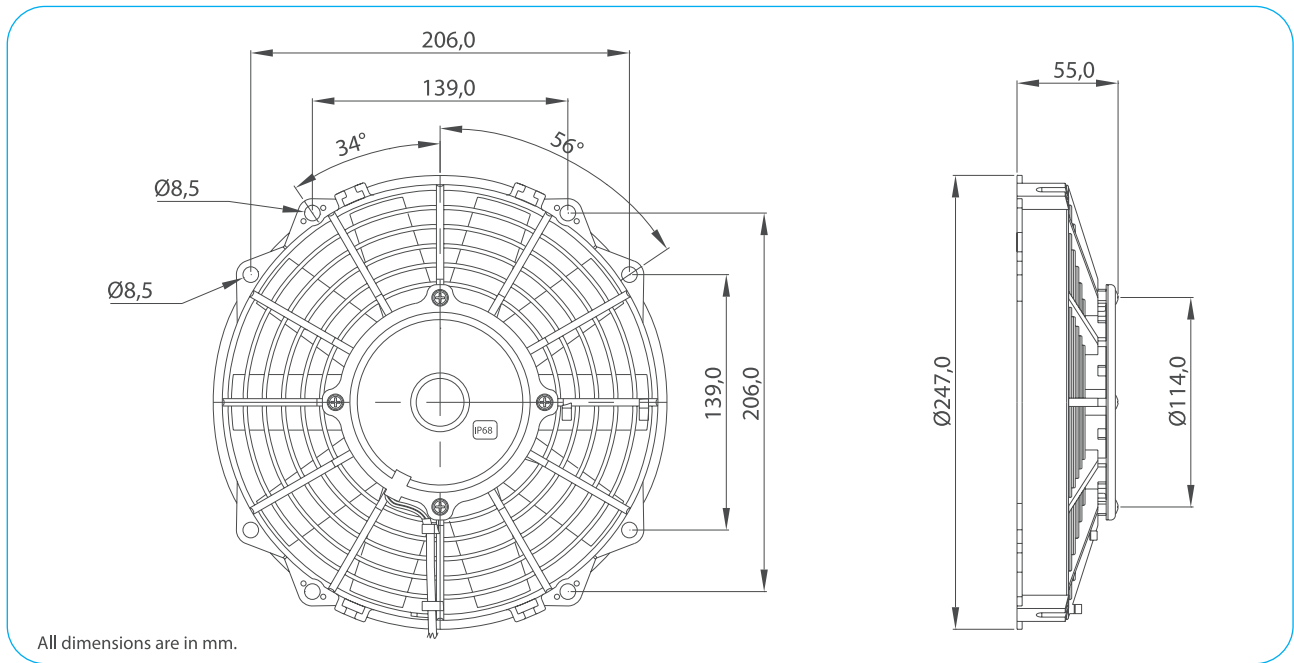

Test Voltage	V	26,0
Nominal Current	A	3,1
Nominal Speed	rpm	3.400
Max. St. Pressure	mmH ₂ O	27,5
Max. Airflow	m ³ /h	1.060
Weight	kg	1,3



TEST VOLTAGE = 26,0 VDC	Static Pressure	Air Flow Rate	Current
	mm H ₂ O	m ³ /h	A
	0,0	1056,2	3,0
	2,5	1010,5	3,0
	5,0	950,7	3,1
	7,5	866,5	3,2
	10,0	744,0	3,2
	12,5	590,4	3,2
	15,0	439,2	3,2
	17,5	331,7	3,2
20,0	253,3	3,3	
27,5	0,0	3,5	

Static Pressure: 1 mm H₂O = 0,04in H₂O = 9,8 Pa
Air Flow Rate: 1 m³/h = 0,59 cfm

