

Part Numbers	Specifications	Applications	Features	Options
6402207 PULLER / STR. BLADE	DIAMETER 10" (255 mm)	HVAC Systems	Waterproof, IP68 (LL) Long Life High Efficiency	Mounting brackets EMC (Certified) Thermal Protector (ELL) Extreme Long Life
6402208 PUSHER / STR. BLADE	LOW PROFILE 24V 130W			

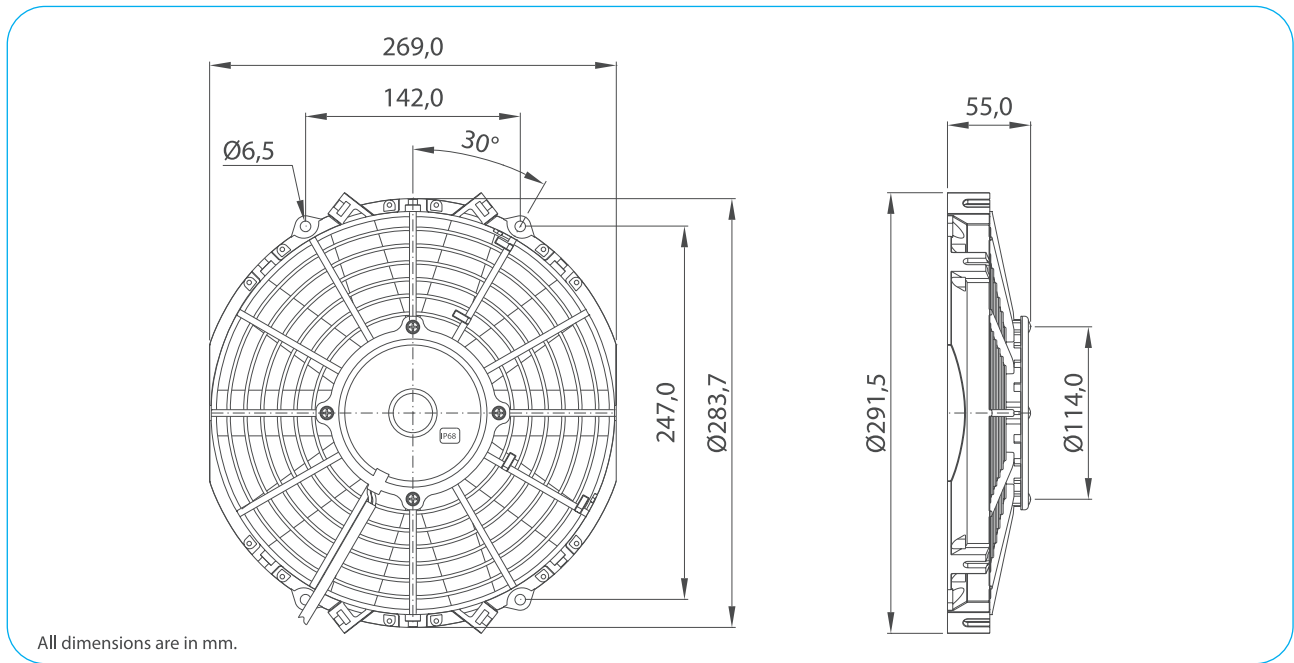

Test Voltage	V	26,0
Nominal Current	A	3,1
Nominal Speed	rpm	2.950
Max. St. Pressure	mmH ₂ O	24,0
Max. Airflow	m ³ /h	1.320
Weight	kg	1,3



TEST VOLTAGE = 26,0 VDC	Static Pressure	Air Flow Rate	Current
	mm H ₂ O	m ³ /h	A
	0,0	1322,8	3,1
	2,5	1251,6	3,2
	5,0	1161,9	3,3
	7,5	1040,1	3,4
	10,0	871,2	3,4
	12,5	663,8	3,4
	15,0	472,5	3,4
	17,5	335,8	3,5
20,0	220,3	3,5	
23,9	0,0	3,5	

Static Pressure: 1 mm H₂O = 0,04in H₂O = 9,8 Pa
Air Flow Rate: 1 m³/h = 0,59 cfm

