

Part Numbers	Specifications	Applications	Features	Options
<b>6402216</b> PULLER / STR. BLADE	<b>DIAMETER 11" (280 mm)</b>	HVAC Systems	Waterproof, IP68 (LL) Long Life High Efficiency	Mounting brackets EMC (Certified) Thermal Protector (ELL) Extreme Long Life
<b>6402217</b> PUSHER / STR. BLADE	<b>LOW PROFILE</b> <b>12V 130W</b>			

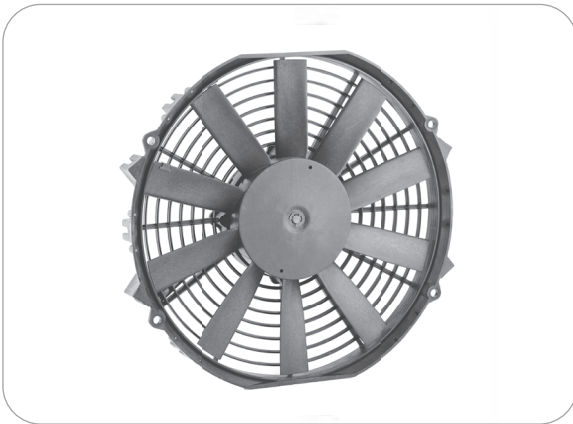

Test Voltage	V	13,0
Nominal Current	A	5,6
Nominal Speed	rpm	2.640
Max. St. Pressure	mmH <sub>2</sub> O	19,0
Max. Airflow	m <sup>3</sup> /h	1.370
Weight	kg	1,4

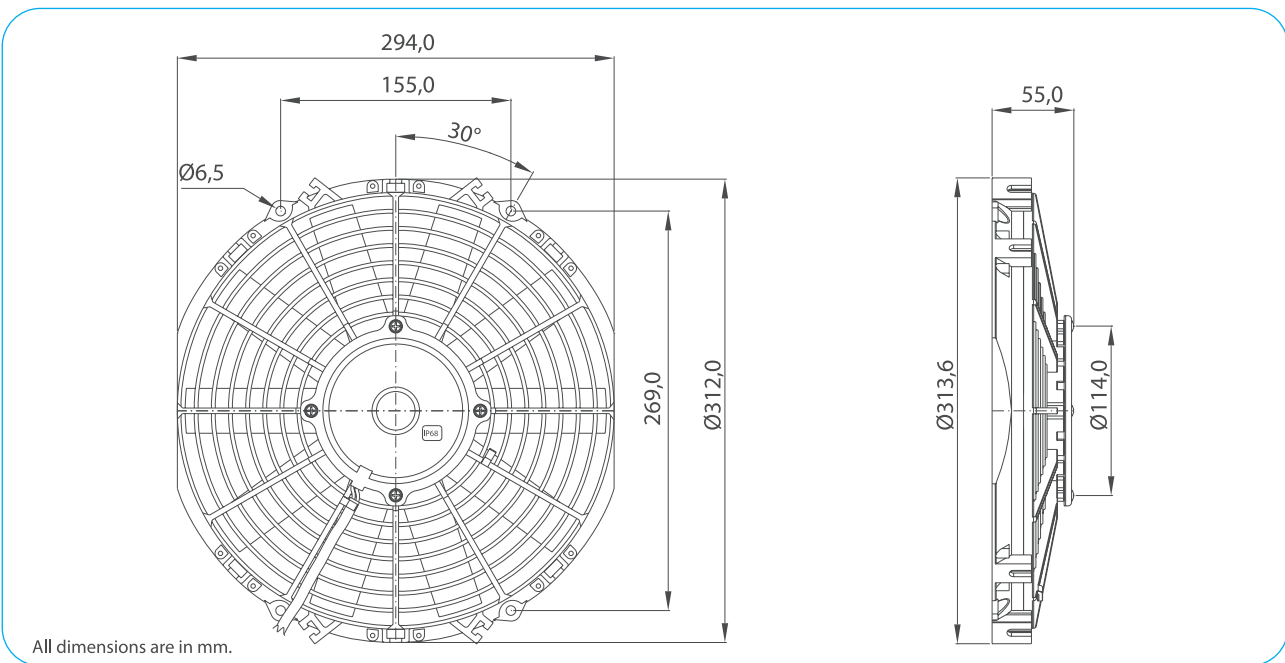

TEST VOLTAGE = 13,0 VDC	Static Pressure	Air Flow Rate	Current
	mm H <sub>2</sub> O	m <sup>3</sup> /h	A
	0,0	1372,7	5,4
	2,5	1249,4	5,7
	5,0	1113,7	6,0
	7,5	933,4	6,2
	10,0	665,7	6,1
	12,5	432,9	6,0
	15,0	269,4	6,2
	18,8	0,0	6,3

Static Pressure: 1 mm H<sub>2</sub>O = 0,04in H<sub>2</sub>O = 9,8 Pa  
Air Flow Rate: 1 m<sup>3</sup>/h = 0,59 cfm

