

Part Numbers	Specifications	Applications	Features	Options
6402218 PULLER / STR. BLADE	DIAMETER 11" (280 mm)	HVAC Systems	Waterproof, IP68 (LL) Long Life High Efficiency	Mounting brackets EMC (Certified) Thermal Protector (ELL) Extreme Long Life
6402219 PUSHER / STR. BLADE	LOW PROFILE 24V 130W			

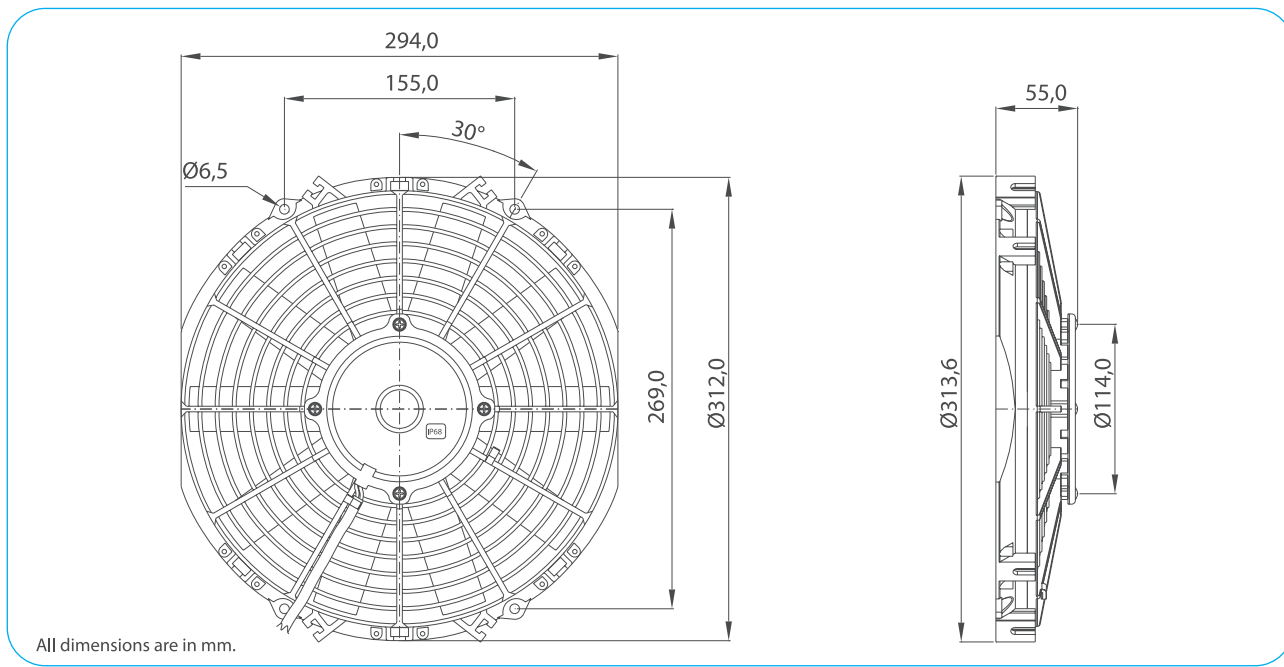

Test Voltage	V	26,0
Nominal Current	A	2,6
Nominal Speed	rpm	2.680
Max. St. Pressure	mmH ₂ O	19,0
Max. Airflow	m ³ /h	1.400
Weight	kg	1,4



TEST VOLTAGE = 26,0 VDC	Static Pressure	Air Flow Rate	Current
	mm H ₂ O	m ³ /h	A
	0,0	1393,1	2,6
	2,5	1273,6	2,7
	5,0	1128,1	2,8
	7,5	938,2	2,9
	10,0	698,7	2,9
	12,5	476,6	2,9
	15,0	282,4	2,9
	18,8	0,0	3,0

Static Pressure: 1 mm H₂O = 0,04in H₂O = 9,8 Pa
Air Flow Rate: 1 m³/h = 0,59 cfm

