

Part Numbers	Specifications	Applications	Features	Options
6402220 PULLER / STR. BLADE	DIAMETER 11" (280 mm)	HVAC Systems	Waterproof, IP68 (LL) Long Life High Efficiency	Mounting brackets EMC (Certified) Thermal Protector (ELL) Extreme Long Life
6402221 PUSHER / STR. BLADE	LOW PROFILE 12V 130W			

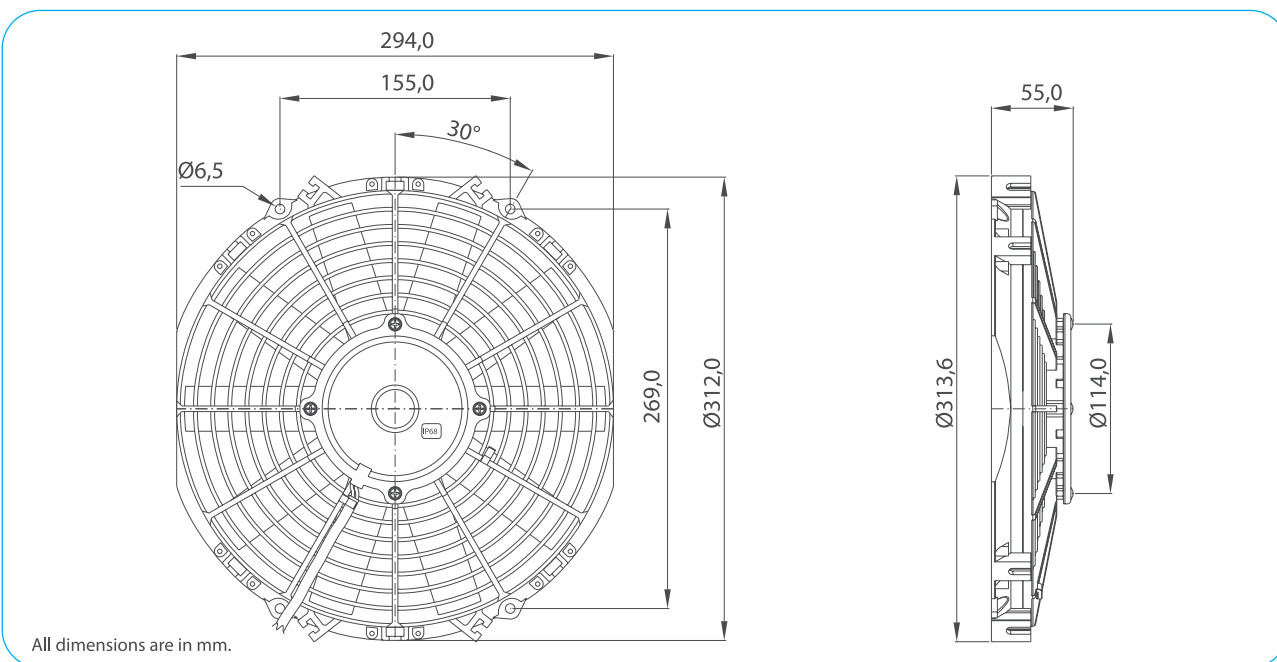

Test Voltage	V	13,0
Nominal Current	A	7,0
Nominal Speed	rpm	2.920
Max. St. Pressure	mmH ₂ O	24,5
Max. Airflow	m ³ /h	1.600
Weight	kg	1,4



TEST VOLTAGE = 13,0 VDC	Static Pressure	Air Flow Rate	Current
	mm H ₂ O	m ³ /h	A
	0,0	1595,9	6,9
	2,5	1476,7	7,2
	5,0	1351,9	7,5
	7,5	1215,5	7,8
	10,0	1044,1	8,0
	12,5	814,6	8,0
	15,0	585,2	7,9
	17,5	413,9	7,9
20,0	275,5	8,0	
24,7	0,0	8,2	

Static Pressure: 1 mm H₂O = 0,04in H₂O = 9,8 Pa
Air Flow Rate: 1 m³/h = 0,59 cfm

