

Part Numbers	Specifications	Applications	Features	Options
6402237 PULLER / STR. BLADE	DIAMETER 12" (305 mm)	HVAC Systems	Waterproof, IP68 (LL) Long Life High Efficiency	Mounting brackets EMC (Certified) Thermal Protector (ELL) Extreme Long Life
6402238 PUSHER / STR. BLADE	LOW PROFILE 24V 130W			

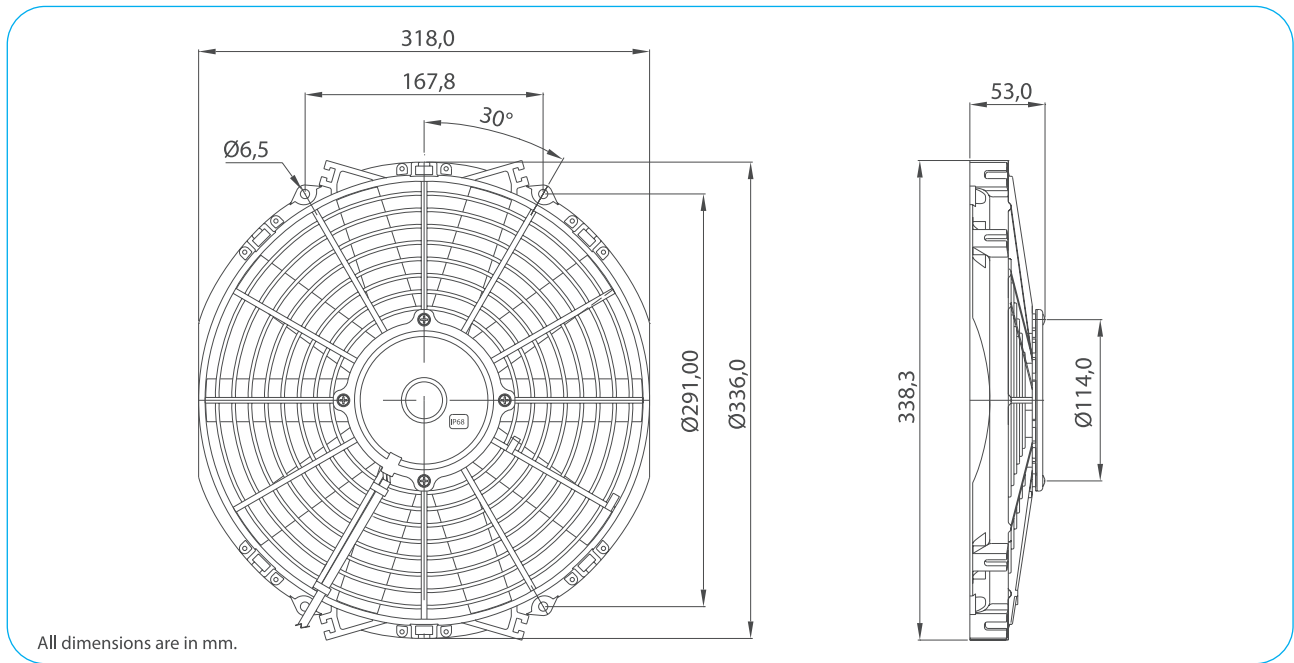

Test Voltage	V	26,0
Nominal Current	A	2,6
Nominal Speed	rpm	2.560
Max. St. Pressure	mmH ₂ O	19,0
Max. Airflow	m ³ /h	1.600
Weight	kg	1,5



TEST VOLTAGE = 26,0 VDC	Static Pressure	Air Flow Rate	Current
	mm H ₂ O	m ³ /h	A
	0,0	1595,4	2,5
	2,5	1448,0	2,7
	5,0	1294,3	2,9
	7,5	1101,2	3,0
	10,0	820,4	3,0
	12,5	552,6	3,0
	15,0	336,0	3,0
18,8	0,0	3,0	

Static Pressure: 1 mm H₂O = 0,04in H₂O = 9,8 Pa
Air Flow Rate: 1 m³/h = 0,59 cfm

