

Part Numbers	Specifications	Applications	Features	Options
<b>6402247</b> PULLER / S BLADE	<b>DIAMETER 12" (305 mm)</b>	HVAC Systems	Waterproof, IP68 (LL) Long Life High Efficiency	Mounting brackets EMC (Certified) Thermal Protector (ELL) Extreme Long Life
<b>6402248</b> PUSHER / S BLADE	<b>LOW PROFILE</b> <b>24V 160W</b>			

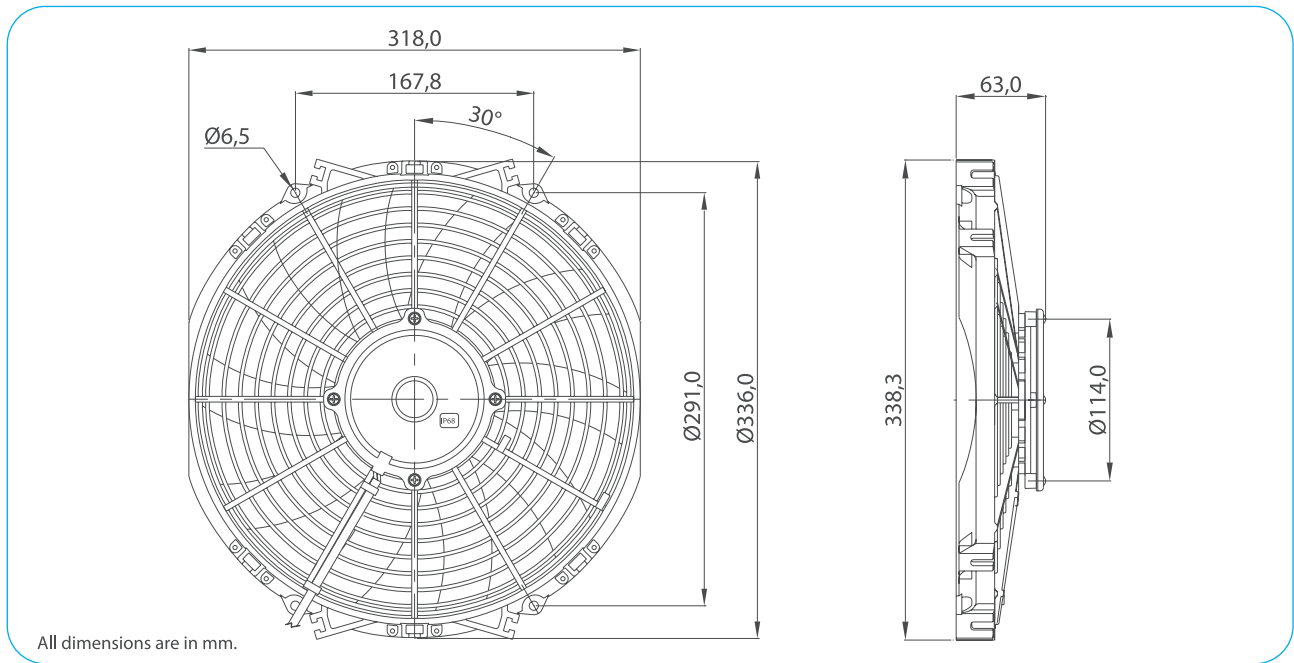

Test Voltage	V	26,0
Nominal Current	A	6,0
Nominal Speed	rpm	3.250
Max. St. Pressure	mmH <sub>2</sub> O	29,0
Max. Airflow	m <sup>3</sup> /h	2.250
Weight	kg	1,8



TEST VOLTAGE = 26,0 VDC	Static Pressure	Air Flow Rate	Current
	mm H <sub>2</sub> O	m <sup>3</sup> /h	A
	0,0	2240,5	5,9
	2,5	2149,3	6,2
	5,0	2025,2	6,4
	7,5	1844,0	6,5
	10,0	1602,6	6,6
	15,0	1087,0	6,7
	20,0	635,9	7,0
	25,0	269,9	7,3
29,0	0,0	7,5	

Static Pressure: 1 mm H<sub>2</sub>O = 0,04in H<sub>2</sub>O = 9,8 Pa  
Air Flow Rate: 1 m<sup>3</sup>/h = 0,59 cfm

