

Part Numbers	Specifications	Applications	Features	Options
6402255 PULLER / STR. BLADE	DIAMETER 14" (350 mm)	HVAC Systems	Waterproof, IP68 (LL) Long Life High Efficiency	Mounting brackets EMC (Certified) Thermal Protector (ELL) Extreme Long Life
6402256 PUSHER / STR. BLADE	LOW PROFILE 24V 130W			

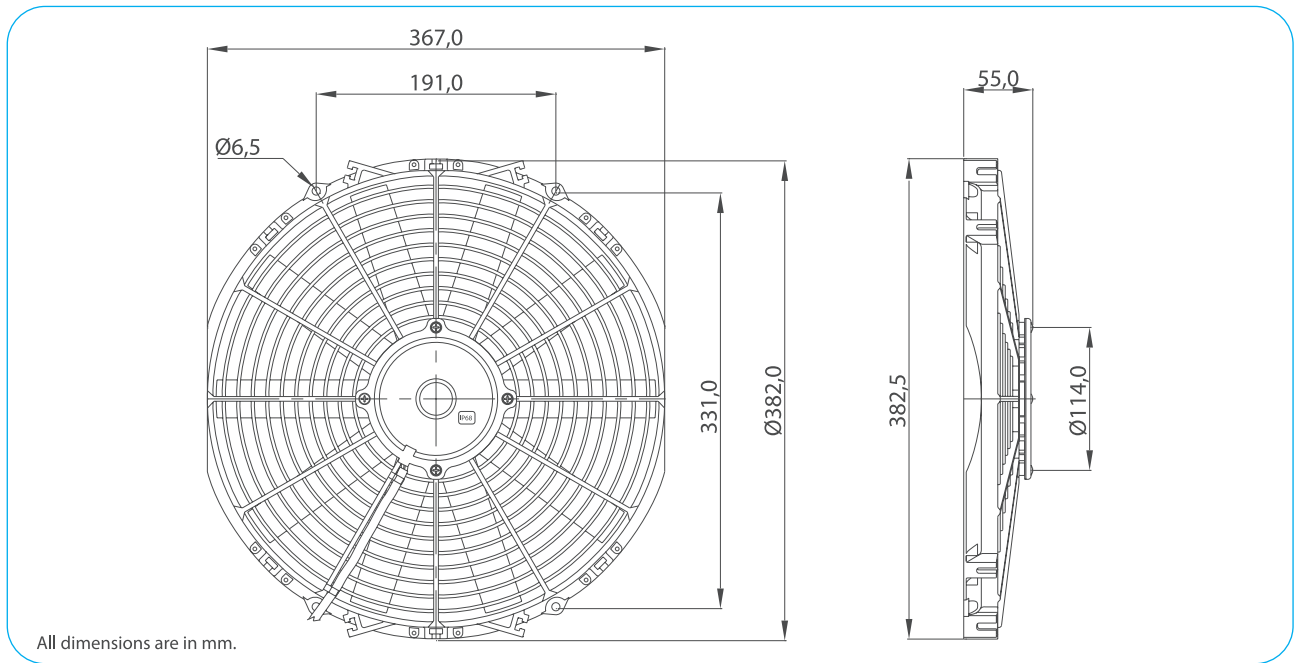

Test Voltage	V	26,0
Nominal Current	A	3,0
Nominal Speed	rpm	2.460
Max. St. Pressure	mmH ₂ O	18,0
Max. Airflow	m ³ /h	1.860
Weight	kg	1,5



TEST VOLTAGE = 26,0 VDC	Static Pressure	Air Flow Rate	Current
	mm H ₂ O	m ³ /h	A
	0,0	1866,6	3,0
	2,5	1683,4	3,2
	5,0	1476,9	3,4
	7,5	1215,5	3,4
	10,0	890,5	3,3
	12,5	590,9	3,3
	15,0	327,6	3,3
17,8	0,0	3,3	

Static Pressure: 1 mm H₂O = 0,04in H₂O = 9,8 Pa
Air Flow Rate: 1 m³/h = 0,59 cfm

