

Part Numbers	Specifications	Applications	Features	Options
6403292 PUSHER / PULLER	DIAMETER 12" (305 mm) LOW PROFILE 12V 130W	HVAC Systems	Waterproof, IP68 (LL) Long Life Reversible Airflow High Efficiency	Mounting brackets EMC (Certified) Thermal Protector (ELL) Extreme Long Life

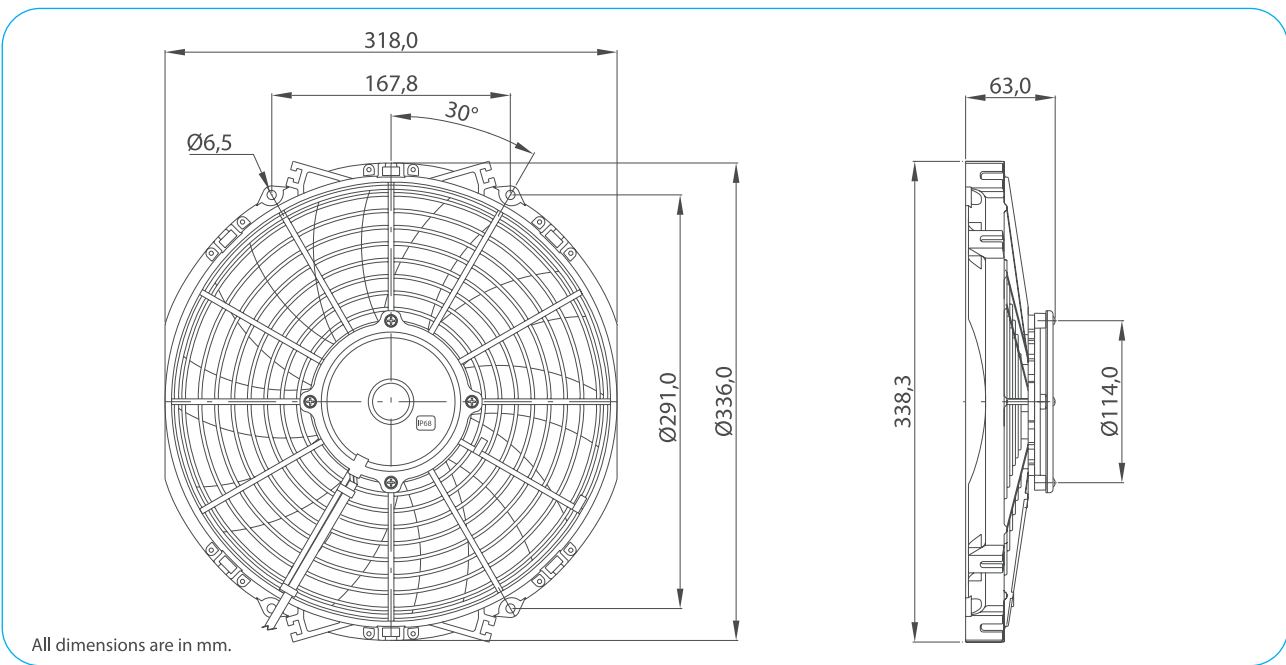

Test Voltage	V	13,0
Nominal Current	A	7,0
Nominal Speed	rpm	2.380
Max. St. Pressure	mmH ₂ O	14,0
Max. Airflow	m ³ /h	1.790
Weight	kg	1,6



TEST VOLTAGE = 13,0 VDC

Static Pressure	Air Flow Rate	Current
mm H ₂ O	m ³ /h	A
0,0	1785,4	6,7
2,5	1578,4	7,2
5,0	1268,2	7,4
7,5	888,6	7,2
10,0	581,7	7,1
12,5	258,2	7,5
14,2	0,0	8,0

Static Pressure: 1 mm H₂O = 0,04in H₂O = 9,8 Pa
Air Flow Rate: 1 m³/h = 0,59 cfm

