

Part Numbers	Specifications	Applications	Features	Options
6402265 PULLER / STR. BLADE	DIAMETER 16" (385 mm)	HVAC Systems	Waterproof, IP68 (LL) Long Life High Efficiency	Mounting brackets EMC (Certified) Thermal Protector (ELL) Extreme Long Life
6401256 PUSHER / STR. BLADE	LOW PROFILE 24V 160W			

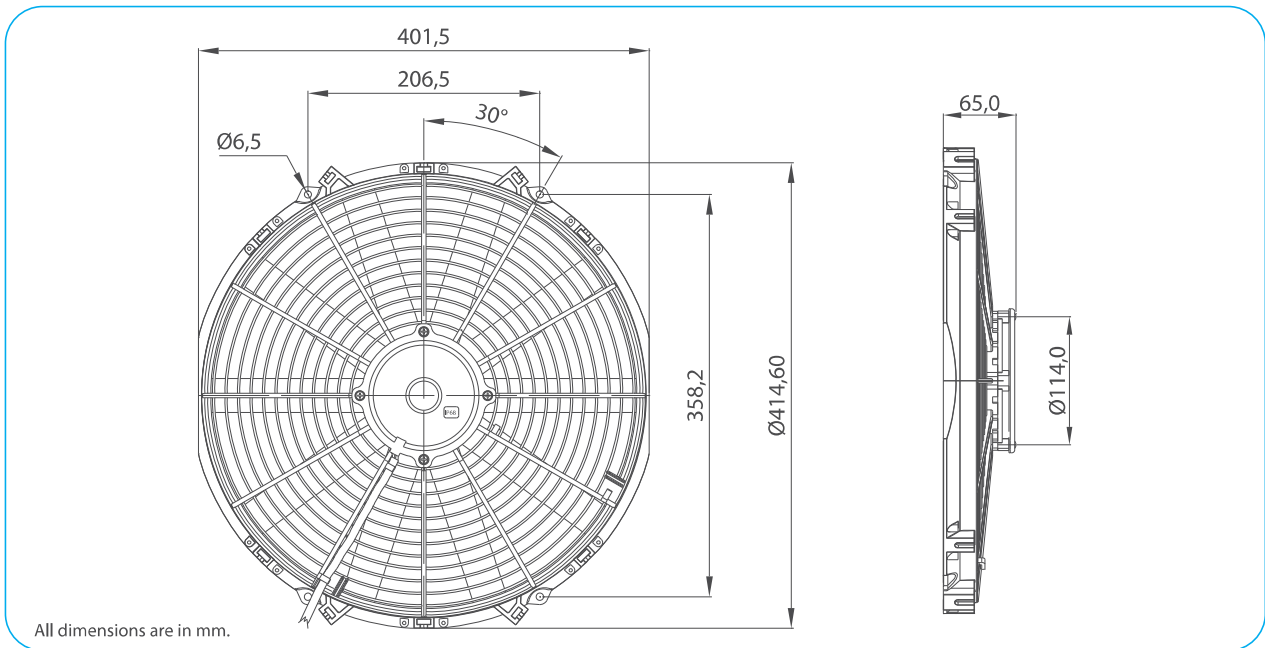

Test Voltage	V	26,0
Nominal Current	A	6,2
Nominal Speed	rpm	2.900
Max. St. Pressure	mmH ₂ O	24,0
Max. Airflow	m ³ /h	2.630
Weight	kg	2,0



TEST VOLTAGE = 26,0 VDC	Static Pressure	Air Flow Rate	Current
	mm H ₂ O	m ³ /h	A
	0,0	2627,7	6,1
	2,5	2450,8	5,8
	5,0	2261,2	6,1
	7,5	2047,8	6,2
	10,0	1771,6	6,3
	12,5	1406,1	6,2
	15,0	1039,9	6,1
	17,5	755,2	6,1
	20,0	499,6	6,0
	24,2	0,0	5,7

Static Pressure: 1 mm H₂O = 0,04in H₂O = 9,8 Pa
Air Flow Rate: 1 m³/h = 0,59 cfm

